

Compiler Construction(CS606)- Lecture Handouts

Lecture 1	5
Course Organization	5
Why Take this Course	6
What are Compilers	6
Typical Compilation.....	7
Issues in Compilation	8
Lecture 2	9
Two-pass Compiler	9
Front End.....	10
Parser	11
Lecture 3	13
Abstract Syntax Trees	13
The Back End.....	14
Lecture 4	15
Register Allocation.....	15
Instruction Scheduling	15
Three-pass Compiler.....	15
Role of Run-time System.....	16
Lecture 5	17
Lexical Analysis.....	17
Lecture 6	20
How to Describe Tokens?	20
Lecture 7	23
Table Encoding of FA	23
Lecture 8	27
NFA ? DFA Construction.....	27
Lecture 9	30
DFA Minimization	30
Lexical Analyzers	30
Lecture 10	33
Running the Scanner	33
Parsing	39

Lecture 11	41
Syntactic Analysis	41
Semantic Analysis	41
Lecture 12	44
Parse Trees	44
Ambiguous Grammars	46
Context-Free Grammars	48
Parsing Techniques	49
Lecture 13	50
Top-Down Parser	50
Lecture 14	54
The LL(1) Property	54
Lecture 15	58
Lecture 16	60
Non-recursive Predictive Parsing	61
LL(1) Parsing Algorithm	62
Lecture 17	64
LL(1) Table Construction	64
Lecture 18	65
FOLLOW Sets	66
Lecture 19	68
Lecture 20	70
Bottom-up Parsing	70
Shift-Reduce Parsing	71
Lecture 21	73
Lecture 22	75
Lecture 23	77
Handles	77
LR(1) Parsers	78
Lecture 24	80
Canonical Collection	80
The Closure Procedure	80
Lecture 25	82

Lecture 26	84
Lecture 27	87
LR Table Construction.....	87
Lecture 28	92
LR(1) Skeleton Parser	92
Shift/Reduce Conflicts.....	92
Lecture 29	94
Lecture 30	96
Parser Generators	96
YACC Parser Generator	96
Lecture 31	98
Beyond Syntax	98
Attribute Grammars	98
Lecture 32	102
Evaluation Methods.....	102
Lecture 33	104
Lecture 34	105
Intermediate Representations.....	107
Lecture 35	108
IR Taxonomy	108
Graphical IRs	108
Linear IRs	110
Lecture 36	111
Assignment Statement.....	111
Lecture 37	112
Representing Linear Codes.....	112
Flow-of-Control Statements	113
Lecture 38	115
Three-Address Statement Types	115
Lecture 39	117
Boolean Expressions.....	117
Lecture 40	122
Lecture 41	125

Lecture 42	129
Code Generation	129
Lecture 43	132
Control Flow Graph - CFG.....	132
Basic Block Code Generation.....	136
Computing Live/Next Use Information	136
Lecture 44	137
Lecture 45	141
Global Data-Flow Analysis	141
DAGs and optimization	143
Register Allocation.....	144

Lecture 1

Course Organization

The course is organized around theory and significant amount of practice. The practice will be in the form of home works and a project. The project is the highlight of the course: you will build a full compiler for subset of Java- like language. The implementation will in C++ and you will generate Intel x86 assembly language code. The project will be done in six parts; each will be a programming assignment.

The grade distribution will be

<i>Theory</i>	Homeworks	10%
	Exams	50%
<i>Practice</i>	Project	40%

The primary text for the course is *Compilers – Principles, Techniques and Tools* by Aho, Sethi and Ullman. This is also called the Dragon Book; here is the image on the cover of the book:

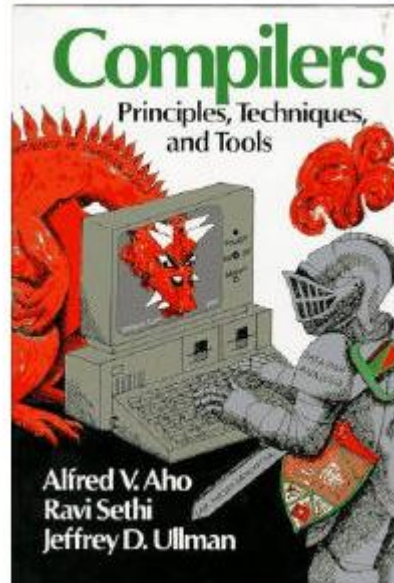

Why Take this Course

There are number of reason for why you should take this course. Let's go through a few

Reason #1: understand compilers and languages

We all have used one or computer languages to write programs. We have used compilers to "compile" our code and eventually turn it into an executable. While we worry about data structures, algorithms and all the functionality that our application is supposed to provide, we perhaps overlook the programming language, the structure of the code and the language semantics. In this course, we will attempt to understand the code structure, understand language semantics and understand relation between source code and generated machine code. This will allow you to become a better programmer

Reason #2: nice balance of theory and practice

We have studied a lot of theory in various CS courses related to languages and grammar. We have covered mathematical models: regular expressions, automata, grammars and graph algorithms that use these models. We will now have an opportunity to put this theory into practice by building a real compiler.

Reason #3: programming experience

Creating a compiler entails writing a large computer program which manipulates complex data structures and implement sophisticated algorithm. In the process, we will learn more about C++ and Intel x86 assembly language. The experience, however, will be applicable if we desire to use another programming language, say Java, and generate code for architecture other than Intel.

What are Compilers

Compilers translate information from one represent ation to another. Thus, a tool that translates, say, Russian into English could be labeled as a compiler. In this course, however, information = program in a computer language. In this context, we will talk of compilers such as Typical Compiler Examples: C++ Builder, Microsoft Visual Studio Express, Microsoft Visual C++ 2012, VBCC.. Application that convert, for example, a Word file to PDF or PDF to Postscript will be called "translators". In this course we will study typical compilation: from programs written in high- level languages to low- level object code and machine code.

Typical Compilation

Consider the source code of C function

```
int expr( int n )
{
    int d;
    d = 4*n*n*(n+1)*(n+1); return
    d;
}
```

Expressing an algorithm or a task in C is optimized for human readability and comprehension. This presentation matches human notions of grammar of a programming language. The function uses named constructs such as variables and procedures which aid human readability. Now consider the assembly code that the C compiler gcc generates for the Intel platform:

```
.globl _expr
_expr:
    pushl %ebp movl
    %esp,%ebp subl
    $24,%esp
    movl 8(%ebp),%eax
    movl %eax,%edx
    leal 0,(%edx,4),%eax movl
    %eax,%edx imull
    8(%ebp),%edx movl
    8(%ebp),%eax incl %eax
    imull %eax,%edx movl
    8(%ebp),%eax incl
    %eax
    imull %eax,%edx movl
    %edx,-4(%ebp) movl -
    4(%ebp),%edx movl
    %edx,%eax
    jmp L2
    .align 4
L2:
    leave
    ret
```

The assembly code is optimized for hardware it is to run on. The code consists of machine instructions, uses registers and unnamed memory locations. This version is much harder to understand by humans

Issues in Compilation

The translation of code from some human readable form to machine code must be “correct”, i.e., the generated machine code must execute precisely the same computation as the source code. In general, there is no unique translation from source language to a destination language. No algorithm exists for an “ideal translation”.

Translation is a complex process. The source language and generated code are very different. To manage this complex process, the translation is carried out in multiple passes.

Lecture 2

Two-pass Compiler

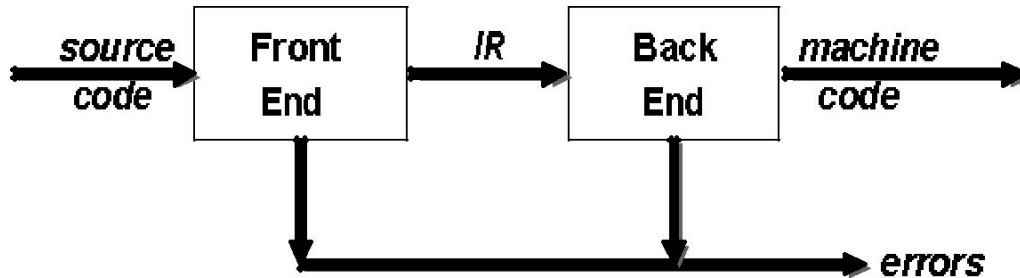

The figure above shows the structure of a two-pass compiler. The front end maps legal source code into an intermediate representation (IR). The back end maps IR into target machine code. An immediate advantage of this scheme is that it admits multiple front ends and multiple passes.

The algorithms employed in the front end have polynomial time complexity while majority of those in the backend are NP-complete. This makes compiler writing a challenging task.

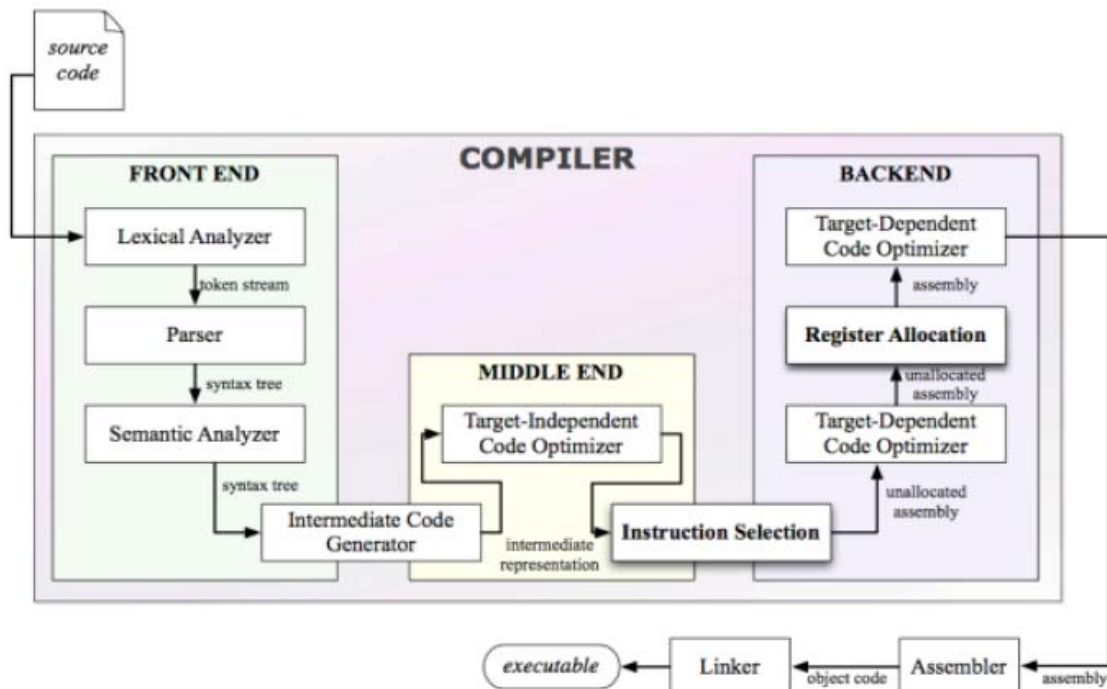

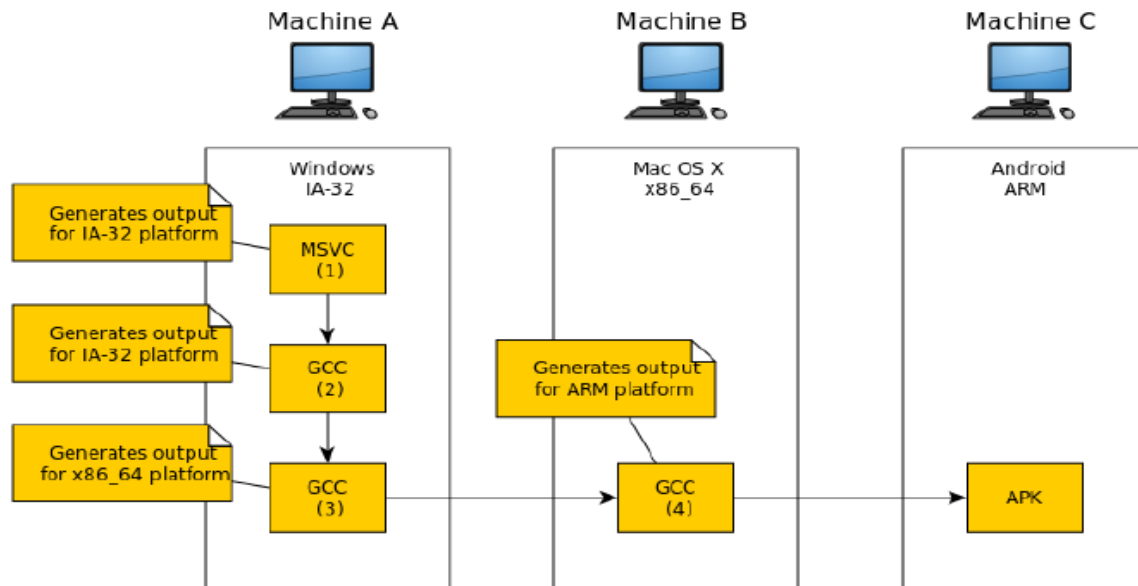

Picture of cross compile like GCC for compilation of C code and generating code for multiple platforms.

Let us look at the details of the front and back ends.

Front End

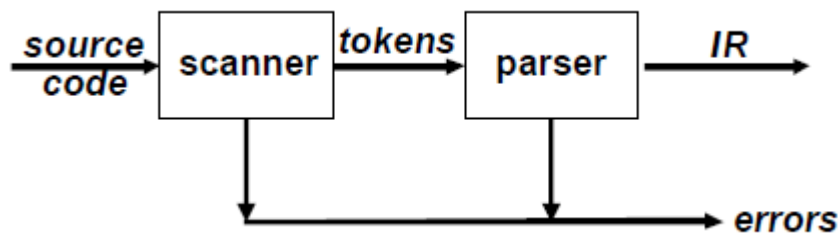

The front end recognizes legal and illegal programs presented to it. When it encounters errors, it attempts to report errors in a useful way. For legal programs, front end produces IR and preliminary storage map for the various data structures declared in the program. The front end consists of two modules:

1. Scanner
2. Parser

Scanner

The scanner takes a program as input and maps the character stream into “words” that are the basic unit of syntax. It produces pairs – a word and its part

of speech. For example, the input

$$x = x + y$$

becomes

```
<id,x>
<assign,=
> <id,x>
<op,+>
<id,y>
```

We call the pair “<token type, word>” a *token*. Typical tokens are: *number*, *identifier*, *+*, *-*, *new*, *while*, *if*.

Parser

The parser takes in the stream of tokens, recognizes context-free syntax and reports errors. It guides context-sensitive (“semantic”) analysis for tasks like type checking. The parser builds IR for source program.

The syntax of most programming languages is specified using Context-Free Grammars (CFG). Context-free syntax is specified with a grammar $G=(S,N,T,P)$ where

- S is the *start* symbol
- N is a set of *non-terminal* symbols
- T is set of *terminal* symbols or words
- P is a set of *productions* or rewrite rules

For example, the Context-Free Grammar for arithmetic expressions is

1.	<i>goal</i>	?	<i>expr</i>
2.	<i>expr</i>	?	<i>expr op term</i>
3.			<i>term</i>
4.	<i>term</i>	?	<u>number</u>
5.			<u>id</u>
6.	<i>op</i>	?	+
7.			-

For this CFG,

```
S = goal
T = { number, id, +, - }
N = { goal, expr, term, op }
P = { 1, 2, 3, 4, 5, 6, 7 }
```

Given a CFG, we can *derive* sentences by repeated substitution. Consider the sentence

$$x + 2 - y$$

<i>Production</i>	<i>Result</i>
	<i>goal</i>
1: <i>goal</i> → <i>expr</i>	<i>expr</i>
2: <i>expr</i> → <i>expr op term</i>	<i>expr op term</i>
5: <i>term</i> → <u><i>id</i></u>	<i>expr op y</i>
7: <i>op</i> → <i>-</i>	<i>expr - y</i>
2: <i>expr</i> → <i>expr op term</i>	<i>expr op term - y</i>
4: <i>term</i> → <u><i>number</i></u>	<i>expr op 2 - y</i>
6: <i>op</i> → <i>+</i>	<i>expr + 2 - y</i>
3: <i>expr</i> → <i>term</i>	<i>term + 2 - y</i>
5: <i>term</i> → <u><i>id</i></u>	<i>x + 2 - y</i>

To recognize a valid sentence in some CFG, we *reverse* this process and build up a *parse*, thus the name “parser”.

Lecture 3

A parse can be represented by a tree: *parse tree* or *syntax tree*. For example, here is the parse tree for the expression $x+2-y$

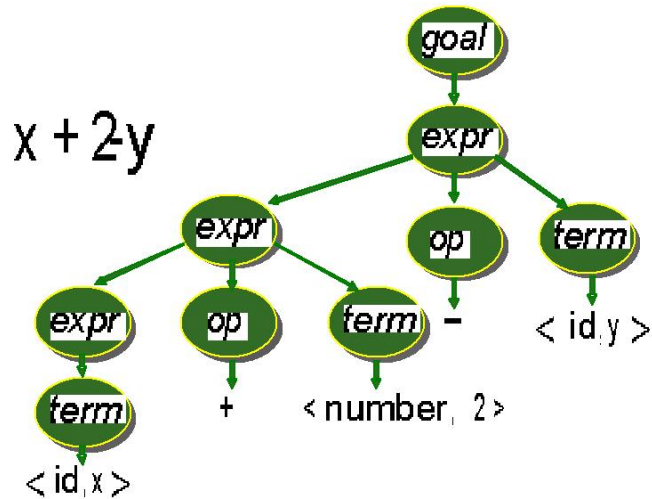

The parse tree captures all rewrite during the derivation. The derivation can be extracted by starting at the root of the tree and working towards the leaf nodes.

Abstract Syntax Trees

The parse tree contains a lot of unneeded information. Compilers often use an *abstract syntax tree (AST)*. For example, the AST for the above parse tree is

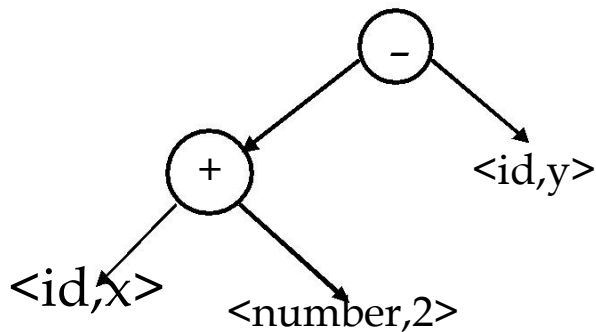

This is much more concise; AST summarizes grammatical structure without the details of derivation. ASTs are one kind of *intermediate representation (IR)*.

The Back End

The back end of the compiler translates IR into target machine code. It chooses machine (assembly) instructions to implement each IR operation. The back end ensures conformance with system interfaces. It decides which values to keep in registers in order to avoid memory access; memory access is far slower than register access.

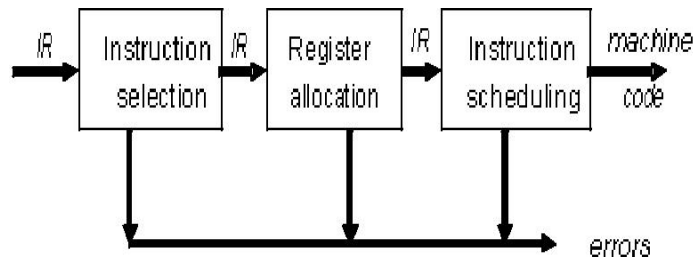

The back end is responsible for instruction selection so as to produce fast and compact code. Modern processors have a rich instruction set. The back end takes advantage of target features such as addressing modes. Usually, instruction selection is viewed as a pattern matching problem that can be solved by dynamic programming based algorithms. Instruction selection in compilers was spurred by the advent of the VAX-11 which had a CISC (Complex Instruction Set Computer) architecture. The VAX-11 had a large instruction set that the compiler could work with.

Lecture 4

CISC architecture provided a rich set of instructions and addressing modes but it made the job of the compiler harder when it came to generate efficient machine code. The RISC architecture simplified this problem.

Register Allocation

Registers in a CPU play an important role for providing high speed access to operands. Memory access is an order of magnitude slower than register access. The back end attempts to have each operand value in a register when it is used. However, the back end has to manage a limited set of resources when it comes to the register file. The number of registers is small and some registers are pre-allocated for specialized use, e.g., program counter, and thus are not available for use to the back end. Optimal register allocation is *NP-Complete*.

Instruction Scheduling

Modern processors have multiple functional units. The back end needs to schedule instructions to avoid hardware stalls and interlocks. The generated code should use all functional units productively. Optimal scheduling is *NP-Complete* in nearly all cases.

Three-pass Compiler

There is yet another opportunity to produce efficient translation: most modern compilers contain three stages. An intermediate stage is used for code improvement or optimization. The topology of a three-pass compiler is shown in the following figure:

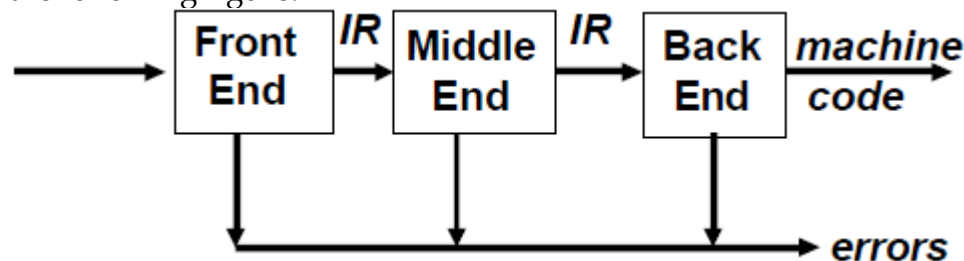

The middle end analyzes IR and rewrites (or *transforms*) IR. Its primary goal is to reduce running time of the compiled code. This may also improve space usage, power consumption, etc. The middle end is generally termed the “Optimizer”. Modern optimizers are structured as a series of passes:

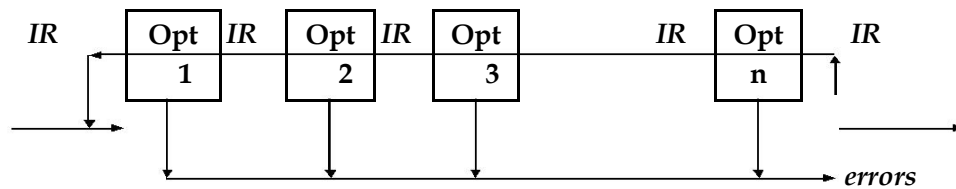

Typical transformations performed by the optimizer are:

- Discover & propagate some constant value
- Move a computation to a less frequently executed place
- Specialize some computation based on context
- Discover a redundant computation & remove it
- Remove useless or unreachable code
- Encode an idiom in some particularly efficient form

Role of Run-time System

The executable code typically runs as a process in an Operating System Environment. The application will need a number of resources from the OS. For example, dynamic memory allocation and input output. The process may spawn more processes or threads. If the underlying architecture has multiple processors, the application may want to use them. Processes communicate with other and may share resources. Compilers need to have an intimate knowledge of the runtime system to make effective use of the runtime environment and machine resources. The issues in this context are:

- Memory management
- Allocate and de-allocate memory
- Garbage collection
- Run-time type checking
- Error/exception processing
- Interface to OS - I/O
- Support for parallelism
- Parallel threads
- Communication and synchronization

Lecture 5

Lexical Analysis

The scanner is the first component of the front-end of a compiler; parser is the second

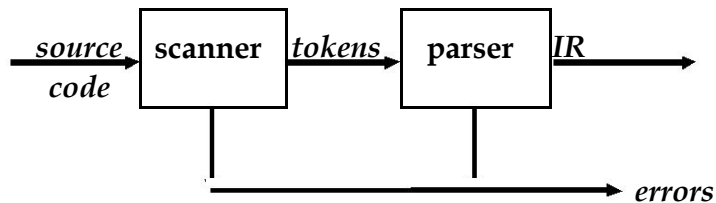

The task of the scanner is to take a program written in some programming language as a stream of characters and break it into a stream of tokens. This activity is called *lexical analysis*. A token, however, contains more than just the words extracted from the input. The lexical analyzer partition input string into substrings, called *words*, and classifies them according to their role.

Tokens

A token is a *syntactic category* in a sentence of a language. Consider the sentence:

He wrote the program

of the natural language English. The words in the sentence are: "He", "wrote", "the" and "program". The blanks between words have been ignored. These words are classified as subject, verb, object etc. These are the roles. Similarly, the sentence in a programming language like C:

```
if(b == 0) a = b
```

the words are "if", "(", "b", "==", "0", ")", "a", "=", and "b". The roles are keyword, variable, boolean operator, assignment operator. The pair <role,word> is given the name *token*. Here are some familiar tokens in programming languages:

- Identifiers: x y11 maxsize
- Keywords: if else while for
- Integers: 2 1000 -445L
- Floats: 2.0 0.0034 1e5
- Symbols: () + * / { } < > ==
- Strings: "enter x" "error"

Ad-hoc Lexer

The task of writing a scanner is fairly straight forward. We can hand-write code to generate tokens. We do this by partitioning the input string by reading left-to-right, recognizing one token at a time. We will need to look-ahead in order to decide where one token ends and the next token begins. The following C++ code present is template for a Lexer class. An object of this class can produce the desired tokens from the input stream.

```
class Lexer
{
    Inputstream s;
    char next; //look ahead
    Lexer(Inputstream _s)
    {
        s = _s;
        next = s.read();
    }

    Token nextToken() {
        if( idChar(next) )return readId(); if( number(next)
        )return readNumber(); if( next == "'" ) return
        readString();
        ...
        ...
    }
    Token readId() { string id =
        ""; while(true){
            char c = input.read();
            if(idChar(c) == false)
                return new Token(TID,id); id = id
            + string(c);
        }
    }
    boolean idChar(char c)
    {
        if( isAlpha(c) ) return true; if( isDigit(c)
        ) return true; if( c == '_' ) return true;

        return false;
    }
    Token readNumber(){ string
        num = "";
        while(true){
```

```

        next = input.read(); if(
        !isNumber(next))
            return new Token(TNUM,num); num
        = num+string(next);
    }
}

```

This works ok, however, there are some problem that we need to tackle.

- We do not know what kind of token we are going to read from seeing first character.
- If token begins with "i", is it an identifier "i" or keyword "if"?
- If token begins with "=", is it "=" or "=="?

We can extend the Lexer class but there are a number of other issues that can make the task of hand-writing a lexer tedious. We need a more principled approach. The most frequently used approach is to use a *lexer generator* that generates efficient tokenizer *automatically*.

Lecture 6

How to Describe Tokens?

Regular Languages are the most popular for specifying tokens because

- These are based on simple and useful theory,
- Are easy to understand and
- Efficient implementations exist for generating lexical analyzers based on such languages.

Languages

Let Σ be a set of characters. Σ is called the *alphabet*. A *language over Σ* is set of strings of characters drawn from Σ . Here are some examples of languages:

- Alphabet=English characters
- Language=English sentences
- Alphabet = ASCII
Language = C++, Java, C# programs

Languages are sets of strings (finite sequence of characters). We need some notation for specifying which sets we want. For lexical analysis we care about *regular languages*. Regular languages can be described using *regular expressions*. Each regular expression is a notation for a regular language (a set of words). If **A** is a regular expression, we write **L(A)** to refer to language denoted by **A**.

Regular Expression

A *regular expression (RE)* is define as

- a** ordinary character from Σ
- ϵ the empty string
- R|S** either R or S
- RS** R followed by S (concatenation)
- R*** concatenation of R zero or more times ($R^* = \epsilon \mid R \mid RR \mid RRR \dots$)

Regular expression extensions are used as convenient notation of complex RE:

- R?** $\epsilon \mid R$ (zero or one R)
- R⁺** RR^* (one or more R)

(R) R (grouping)
 [abc] a | b | c (any of listed)
 [a-z] a | b | ... | z (range)
 [^ab] c | d | ... (anything but 'a''b')

Here are some Regular Expressions and the strings of the language denoted by the RE.

RE	Strings in L(R)
a	"a"
ab	"ab"
a b	"a" "b"
(ab)*	"" "ab" "abab" ...
(a ε)b	"ab" "b"

Here are examples of common tokens found in programming languages.

digit	'0' '1' '2' '3' '4' '5' '6' '7' '8' '9'
integer	digit digit*
identifier	[a-zA-Z_][a-zA-Z0-9_]*

Finite Automaton

We need mechanism to determine if an input string w belongs to $L(R)$, the language denoted by regular expression R . Such a mechanism is called an *acceptor*.

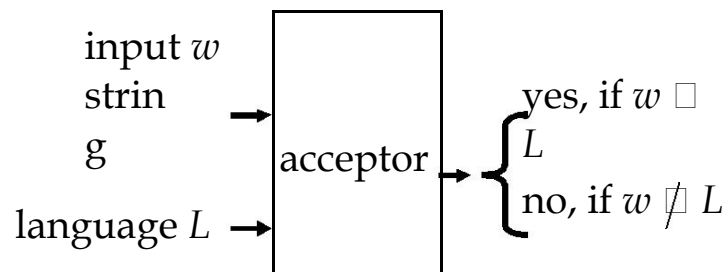

The acceptor is based on Finite Automata (FA). A *Finite Automaton* consists of

- An input alphabet Σ
- A set of states
- A start (initial) state
- A set of transitions
- A set of accepting (final) states

A finite automaton *accepts* a string if we can follow transitions labeled with characters in the string from start state to some accepting state. Here are some examples of FA.

- A FA that accepts only "1"

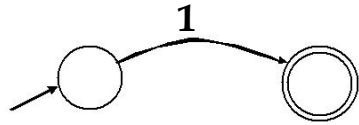

- A FA that accepts any number of 1's followed by a single 0

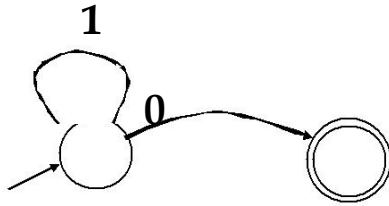

- A FA that accepts ab^*a ($\Sigma: \{a,b\}$)

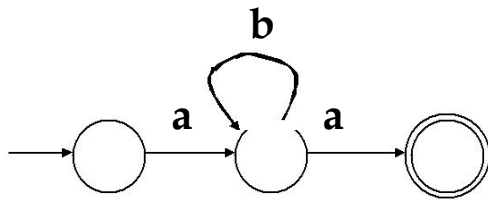

Lecture 7

Table Encoding of FA

A FA can be encoded as a table. This is called a *transition table*. The following example shows a FA encoded as a table.

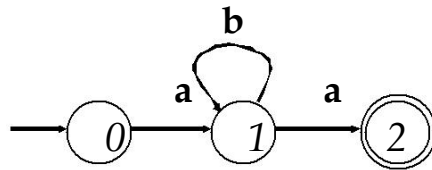

	a	b
0	1	err
1	2	1
2	err	err

The rows correspond to states. The characters of the alphabet set Σ appear in columns. The cells of the table contain the next state. This encoding makes the implementation of the FA simple and efficient. It is equally simple to simulate or run the FA given an alphabet and a string of the language and its associated alphabet set Σ . The C++ code shows such a FA simulator.

```
int trans_table[NSTATES][NCHARS]; int
accept_states[NSTATES];
int state = INITIAL;
while(state != err){
    c = input.read(); if(c == EOF
    ) break;
    state=trans_table[state][c];
}
return accept_states[state];
```

RE ? Finite Automata

We now have a strategy for building lexical analyzer. The tokens we want to recognize are encoded using regular expressions. If we can build a FA for regular expressions, we have our lexical analyzer. The question is can we build

a finite automaton for every regular expression? The answer, fortunately, is yes – build FA inductively based on the definition of Regular Expression (RE). The actual algorithm actually builds *Nondeterministic Finite Automaton* (NFA) from RE. Each RE is converted into an NFA. NFAs are joined together with ϵ -moves. The eventual NFA is then converted into a *Deterministic Finite Automaton* (DFA) which can be encoded as a transition table. Let us discuss how this happens.

Nondeterministic Finite Automaton (NFA)

An NFA can have multiple transitions for one input in a given state. In the following NFA, and input of 1 can cause the automaton to go to state B or C.

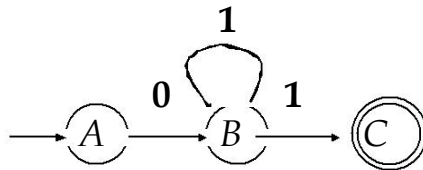

It can also have ϵ -moves; the automaton machine can move from state A to state B without consuming input.

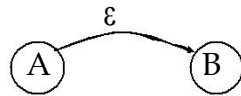

The operation of the automaton is not completely defined by input. A NFA can choose whether to make ϵ -moves and which of multiple transitions to take for a single input. The acceptance of NFA for a given string is achieved if it *can* get in a final state.

Deterministic Finite Automaton (NFA)

In Deterministic Finite Automata (DFA), on the other hand, there is only one transition per input per state. There are no ϵ -moves. Upon execution of the automaton, a DFA can take *only one path* through the state graph and is therefore completely determined by input.

NFAs and DFAs recognize the same set of languages (regular languages). DFAs are easier to implement – table driven. For a given language, the NFA can be simpler than the DFA. DFA can be exponentially larger than NFA. NFAs are the key to automating RE ? DFA construction.

RE ? NFA Construction

The algorithm for RE to DFA conversion is called *Thompson's Construction*. The algorithm appeared in CACM 1968. The algorithm builds an NFA for each RE

term. The NFAs are then combined using ϵ -moves. The NFA is converted into a DFA using the subset construction procedure. The number of states in the resulting DFA are minimized using the *Hopcroft's algorithm*.

Given a RE, we first create NFA pattern for each symbol and each operator. We then join them with ϵ -moves in precedence order. Here are examples of such constructions:

1. NFA for RE **ab**.

The following figures show the construction steps. NFAs for RE **a** and RE **b** are made. These two are combined using an ϵ -move; the NFA for RE **a** appears on the left and is the source of the ϵ -transition.

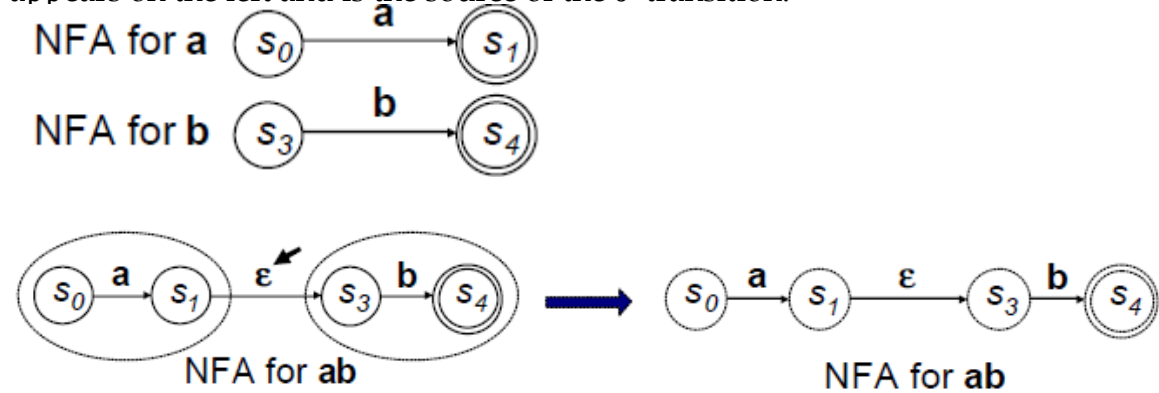

2. NFA for RE **a|b**

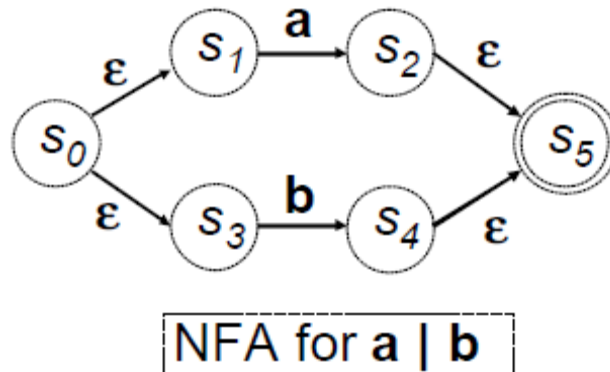

3. NFA for RE **a***

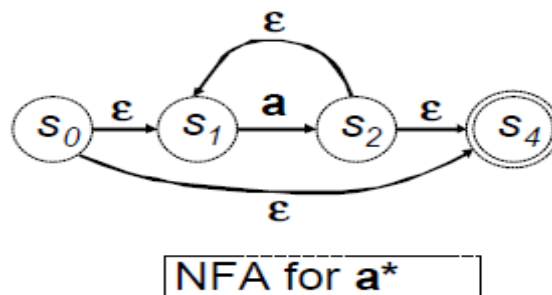

3. NFA for RE $a(b|c)^*$

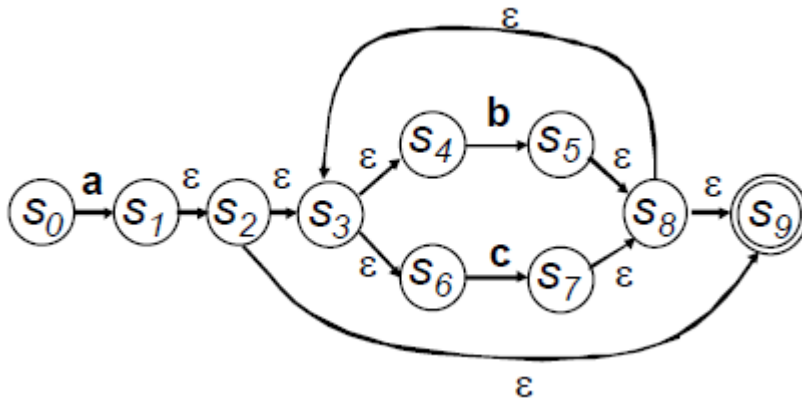

Lecture 8

NFA ? DFA Construction

The algorithm is called *subset construction*. In the transition table of an NFA, each entry is a set of states. In DFA, each entry is a single state. The general idea behind NFA-to-DFA construction is that each DFA state corresponds to a set of NFA states. The DFA uses its state to keep track of all possible states the NFA can be in after reading each input symbol.

We will use the following operations.

- ϵ -closure(T):
set of NFA states reachable from some NFA state s in T on ϵ -transitions alone.
- $move(T, a)$:
set of NFA states to which there is a transition on input a from some NFA state s in set of states T .

Before it sees the first input symbol, NFA can be in any of the state in the set ϵ -closure(s_0), where s_0 is the start state of the NFA. Suppose that exactly the states in set T are reachable from s_0 on a given sequence of input symbols. Let a be the next input symbol. On seeing a , the NFA can move to any of the states in the set $move(T, a)$. Let a be the next input symbol. On seeing a , the NFA can move to any of the states in the set $move(T, a)$. When we allow for ϵ -transitions, NFA can be in any of the states in ϵ -closure($move(T, a)$) after seeing a .

Subset Construction

Algorithm:

Input: NFA N with state set S , alphabet Σ , start state s_0 , final states F
Output: DFA D with state set S' , alphabet Σ , start states, $s_0' = \epsilon$ -closure(s_0), final states F' and transition table: $S' \times \Sigma \rightarrow S'$

// initially, ϵ -closure(s_0) is the only state in D states S' and it is unmarked
 $s_0' = \epsilon$ -closure(s_0)
 $S' = \{s_0'\}$ (unmarked)

while (there is some unmarked state T in S') mark state T
 for all a in Σ do
 $U = \epsilon$ -closure($move(T, a)$);
 if U not already in S'

```

        add U as an unmarked state
        to S' Dtran(T,a) = U;
    end for
end while
F':
for each DFA state S
    if S contains an NFA final state
        mark S as DFA final
        state
    end algorithm

```

Example

Let us apply the algorithm to the NFA for $(a \mid b)^*abb$. Σ is $\{a,b\}$.

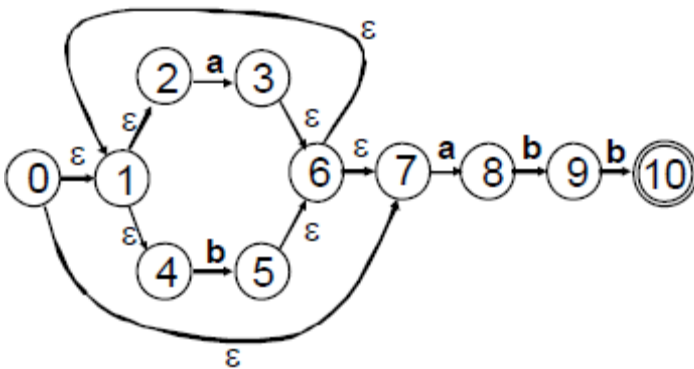

The start state of equivalent DFA is ϵ -closure(0), which is $A = \{0,1,2,4,7\}$; these are exactly the states reachable from state 0 via ϵ -transition. The algorithm tells us to mark A and then compute ϵ -closure(move(A,a))

$move(A,a)$, is the set of states of NFA that have transition on 'a' from members of A. Only 2 and 7 have such transition, to 3 and 8. So, ϵ -closure(move(A,a)) = ϵ -closure($\{3,8\}$) = $\{1,2,3,4,6,7,8\}$. Let $B = \{1,2,3,4,6,7,8\}$; thus $Dtran[A,a] = B$

For input **b**, among states in A, only 4 has transition on **b** to 5. Let $C = \epsilon$ -closure($\{5\}$) = $\{1,2,4,5,6,7\}$. Thus, $Dtran[A,b] = C$

We continue this process with the unmarked sets B and C, i.e., ϵ -closure(move(B,a)), ϵ -closure(move(B,b)), ϵ -closure(move(C,a)) and ϵ -closure(move(C,b)) until all sets and states of DFA are marked. This is certain since there are *only* 2^{11} (!) different subsets of a set of 11 states. A set, once marked, is marked forever. Eventually, the 5 sets are:

1. $A = \{0,1,2,4,7\}$
2. $B = \{1,2,3,4,6,7,8\}$
3. $C = \{1,2,4,5,6,7\}$
4. $D = \{1,2,4,5,6,7,9\}$
5. $E = \{1,2,4,5,6,7,10\}$

A is start state because it contains state 0 and E is the accepting state because it contains state 10.

The subset construction finally yields the following DFA

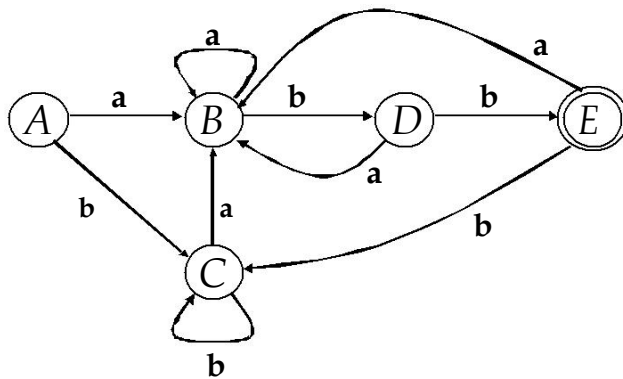

The Resulting DFA can be encoded as the following transition table

State	Input symbol	
	a	b
A	B	C
B	B	D
C	B	C
D	B	E
E	B	C

Lecture 9

DFA Minimization

The generated DFA may have a large number of states. The Hopcroft's algorithm can be used to minimize DFA states. The behind the algorithm is to find groups of *equivalent states*. All transitions from states in one group G_1 go to states in the same group G_2 . Construct the minimized DFA such that there is one state for each group of states from the initial DFA. Here is the minimized version of the DFA created earlier; states A and C have been merged.

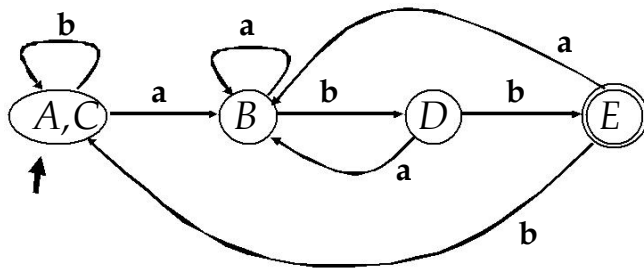

We can construct an optimized acceptor with the following structure:

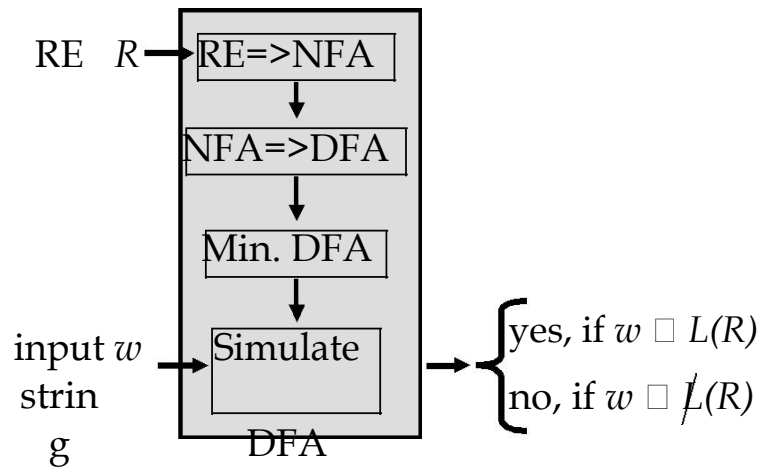

Lexical Analyzers

Lexical analyzers (scanners) use the same mechanism but they have multiple RE descriptions for multiple tokens and have a character stream at the input. The lexical analyzer returns a sequence of matching tokens at the output (or an error) and it always return the longest matching token.

Lexical Analyzer Generators

The process of constructing a lexical analyzer can be automated. We only need to specify Regular expressions for tokens and rules for assigning priorities for multiple longest match cases, e.g, “==” and “=”, “==” is longer.

Two popular lexical analyzer generators are

- **Flex** : generates lexical analyzer in C or C++. It is more modern version of the original Lex tool that was part of the AT&T Bell Labs version of Unix.
- **Jlex**: written in Java. Generates lexical analyzer in Java

Using Flex

We will use for the projects in this course. To use Flex, one has to provide a specification file as input to Flex. Flex reads this file and produces an output file contains the lexical analyzer source in C or C++.

The input specification file consists of three sections: C or C++ and flex definitions

```
%%  
token definitions and actions  
%%  
user code
```

The symbols “%%” mark each section. A detailed guide to Flex is included in supplementary reading material for this course. We will go through a simple example.

The following is the Flex specification file for recognizing tokens found in a C++ function. The file is named “lex.l”; it is customary to use the “.l” extension for Flex input files.

```
%{  
#include "tokdefs.h"  
%}  
D      [0-9]  
L      [a-zA-Z_]  
id     {L}({L}|{D})*  
%%  
"void" {return(TOK_VOID);} "int"  
{return(TOK_INT);}  
"if"   {return(TOK_IF);}
```

```

Specification File lex.l "else"
{return(TOK_ELSE);}
"while"{return(TOK_WHILE)}; "<="
{return(TOK_LE);}
">=" {return(TOK_GE);} "=="
{return(TOK_EQ);} "!="
{return(TOK_NE);} {D}+
{return(TOK_INT);} {id}
{return(TOK_ID);} [\n] | [\t] | [ ] ;
%%

```

The file lex.l includes another file named "tokdefs.h". The content of tokdefs.h are

```

#define TOK_VOID 1
#define TOK_INT 2
#define TOK_IF 3
#define TOK_ELSE 4
#define TOK_WHILE 5
#define TOK_LE 6
#define TOK_GE 7
#define TOK_EQ 8
#define TOK_NE 9
#define TOK_INT 10
#define TOK_ID 111

```

Flex creates C++ classes that implement the lexical analyzer. The code for these classes is placed in the Flex's output file. Here, for example, is the code needed to invoke the scanner; this is placed in main.cpp:

```

void main()
{
    FlexLexer lex;
    int tc = lex.yylex(); while(tc
    != 0) {
        cout << tc << ", " << lex.YYText() << endl; tc =
        lex.yylex();
    }
}

```

The following commands can be used to generate a scanner executable file in windows.

```

flex lex.l g++ -c
lex.cpp
g++ -c main.cpp
g++ -o lex.exe lex.o main.o

```

Lecture 10

Running the Scanner

Here is the output of the scanner when executed and given the file main.cpp as input, i.e., the scanner is being asked to provide tokens found in the file main.cpp:

lex <main.cpp

259,void

258,main

283,(

284,)

285,{

258,FlexLexer

258,lex

290,;

260,int

258,tc

266,=

258,lex

291,.

258,yylex

283,(

284,)

290,;

263,while

283,(

258,tc

276,!=

257,0

284,)

258,cout

279,<<

258,tc

279,<<

292,""

279,<<

258,lex

291,.

258,YYText

283,(

284,)

279,<<

```

258,endl
290,;
258,tc
266,=
258,lex
291,.
258,yylex
283,(
284,)
290,;
286,}

```

Flex input for C++

As an illustration of the power of Flex, here is the input for generating scanner for C++ compiler.

```

/*
 * ISO C++ lexical analyzer.
 * Based on the ISO C++ draft standard of December '96.
 */

%{
#include <ctype.h>
#include <stdio.h>
#include tokdefs.h"

int lineno;

static int yywrap(void);
static void skip_until_eol(void);
static void skip_comment(void);
static int check_identifier(const char *); %}

intsuffix      ([uU][lL]? | ([lL][uU]?)
fracconst      ([0-9]*\.[0-9]+) | ([0-9]+\.)
exppar         [eE][+-]?[0-9]+
t
floatsuffix    [fF]lL
chartext       ([^"]|(\\"))
stringtext     ([^"]|(\\"))
%%
%%
"\n"          { ++lineno; }
[ \t \f \v \r ]+  { /* Ignore whitespace. */ }
"/*"          { skip_comment(); }
"//"          { skip_until_eol(); }
"{"           { return '{'; }

```

```

"<%" { return '{'; }
"}" { return '}'; }
"%>" { return '>'; }
"[" { return '['; }
"<:" { return '['; }
"]" { return ']'; }
":>" { return ']'; }
"(" { return '('; }
")" { return ')'; }
";" { return ';'; }
":" { return ':'; }
"..." { return ELLIPSIS; }
"?" { return '?'; }
":." { return COLONCOLON; }
"." { return '.'; }
".*" { return DOTSTAR; } "+" { return '+'; }
"- " { return '-'; } "*" { return '*'; }
"/" { return '/'; }
"% " { return '%'; }
"^" { return '^'; }
"xor" { return '^'; }
"&" { return '&'; }
"bitand" { return '&'; }
"|" { return '|'; }
"bitor" { return '|'; }
"~" { return '~'; }
"compl" { return '~'; }
"!" { return '!'; }
"not" { return '!'; }
"=" { return '='; }
"<" { return '<'; }
">" { return '>'; }
"+=" { return ADDEQ; }
"-=" { return SUBEQ; }
"*=" { return MULEQ; }
"/=" { return DIVEQ; }
"%=" { return MODEQ; }
"^=" { return XOREQ; }
"xor_eq" { return XOREQ; }
"&=" { return ANDEQ; }
"and_eq" { return ANDEQ; }
"|=" { return OREQ; }
"or_eq" { return OREQ; }
"<<" { return SL; }
">>" { return SR; }
"<<=" { return SLEQ; }
">>=" { return SREQ; }
"==" { return EQ; }
"!=" { return NOTEQ; }

```

```

"not_eq" { return NOTEQ; }
"<=" { return LTEQ; }
">=" { return GTEQ; }
"&&" { return ANDAND; }
"and" { return ANDAND; }
"|" { return OROR; }
"or" { return OROR; }
"++" { return PLUSPLUS; }
"--" { return MINUSMINUS; }
"," { return ','; }
"->*" { return ARROWSTAR; }
"->" { return ARROW; }
"asm" { return ASM; }
"auto" { return AUTO; }
"bool" { return BOOL; }
"break" { return BREAK; }
"case" { return CASE; }
"catch" { return CATCH; }
"char" { return CHAR; }
"class" { return CLASS; }
"const" { return CONST; }
"const_cast" { return CONST_CAST; }
"continue" { return CONTINUE; }
"default" { return DEFAULT; }
"delete" { return DELETE; }
"do" { return DO; }
"double" { return DOUBLE; }
"dynamic_cast" { return DYNAMIC_CAST; }
"else" { return ELSE; }
"enum" { return ENUM; }
"explicit" { return EXPLICIT; }
"export" { return EXPORT; }
"extern" { return EXTERN; }
"false" { return FALSE; }
"float" { return FLOAT; }
"for" { return FOR; }
"friend" { return FRIEND; }
"goto" { return GOTO; }
"if" { return IF; }
"inline" { return INLINE; }
"int" { return INT; }
"long" { return LONG; }
"mutable" { return MUTABLE; }
"namespace" { return NAMESPACE; }
"new" { return NEW; }
"operator" { return OPERATOR; }

```

```

"private" { return PRIVATE; }
"protected" { return PROTECTED; }
"public" { return PUBLIC; }
"register" { return REGISTER; }
"reinterpret_cast" { return REINTERPRET_CAST; }
"return" { return RETURN; }
"short" { return SHORT; }
"signed" { return SIGNED; }
"sizeof" { return SIZEOF; }
"static" { return STATIC; }
"static_cast" { return STATIC_CAST; }
"struct" { return STRUCT; }
"switch" { return SWITCH; }
"template" { return TEMPLATE; }
"this" { return THIS; }
"throw" { return THROW; }
>true" { return TRUE; }
"try" { return TRY; }
"typedef" { return TYPEDEF; }
"typeid" { return TYPEID; }
"typename" { return TYPENAME; }
"union" { return UNION; }
>unsigned" { return UNSIGNED; }
"using" { return USING; }
"virtual" { return VIRTUAL; }
"void" { return VOID; }
"volatile" { return VOLATILE; }
"wchar_t" { return WCHAR_T; }
"while" { return WHILE; }
[a-zA-Z][a-zA-Z_0-9]*
{ return check_identifier(yytext); }

"0"[xX][0-9a-fA-F]+{intsuffix}? { return INTEGER; }
"0"[0-7]+{intsuffix}? { return INTEGER; }
[0-9]+{intsuffix}? { return INTEGER; }

{fracconst}{exppart}?{floatsuffix}? { return FLOATING; }
[0-9]+{exppart}{floatsuffix}? { return FLOATING; }

""{chartext}*"" { return CHARACTER; }
"L""{chartext}*"" { return CHARACTER; }
}

"\ ""{stringtext}*\ "" { return STRING; }
"L\ ""{stringtext}*\ "" { return STRING; }
. { fprintf(stderr,
"%d: unexpected character ` %c \n", lineno,

```

```

        yytext[0]); }
%%
static int
yywrap(void)
{
    return 1;
}
static void
skip_comment(void)
{
    int c1, c2;

    c1 = input();
    c2 = input();

    while(c2 != EOF && !(c1 == '*' && c2 == '/'))
    {
        if (c1 == '\n')
            ++lineno;
        ;
        c1 = c2;
        c2 = input();
    }
}
static void
skip_until_eol(void)
{
    int c;

    while ((c = input()) != EOF && c != '\n')
        ;
    ++lineno;
}

static int check_identifier(const
char *s)
{
    /*
     * This function should check if `s' is a
     * typedef name or a class
     * name, or a enum name, ... etc. or
     * an identifier.
     */
    switch (s[0]) {

```

```

case 'D': return
TYPEDEF_NAME; case 'N':
return NAMESPACE_NAME;
case 'C': return CLASS_NAME;
case 'E': return ENUM_NAME;
case 'T': return TEMPLATE_NAME;
}
return IDENTIFIER;
}

```

Parsing

We now move the second module of the front-end: the parser. Recall the front-end components:

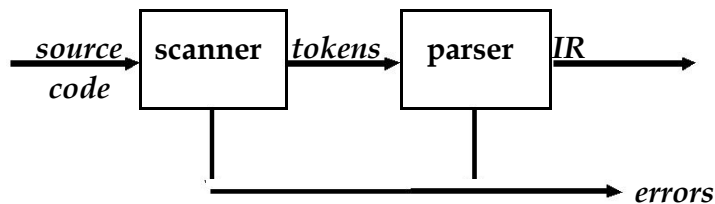

The parser checks the stream of words (tokens) and their parts of speech for grammatical correctness. It determines if the input is *syntactically* well formed. It guides context-sensitive (“semantic”) analysis (type checking). Finally, it builds IR for source program.

Syntactic Analysis

Consider the sentence “He wrote the program”. The structure of the sentence can be described using grammar syntax of English language.

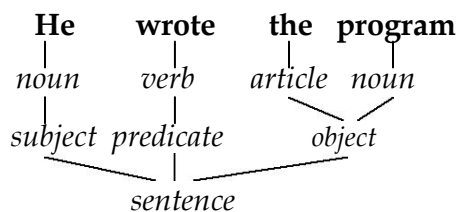

The analogy can be carried over to syntax of sentences in a programming language. For example, an if-statement has the syntax

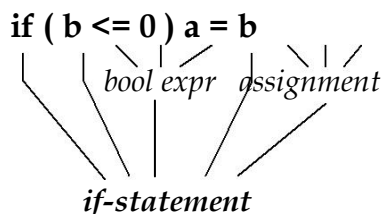

The parser ensures that sentences of a programming language that make up a program abide by the syntax of the language. If there are errors, the parser will detect them and reports them accordingly. Consider the following code segment that contains a number of syntax errors:

```
int* foo(int i, int j))
{
    for(k=0; i j; ) fi( i > j )
        return j;
}
```

It is clear that a scanner based upon regular expressions will not be able to detect syntax error.

Lecture 11

Syntactic Analysis

Consider the following C++ function. There are a number of syntax errors present.

```
1.    int* foo(int i, int j))
2.    {
3.        for(k=0; i j; )
4.            fi( i > j )
5.        return j;
6.    }
```

Line 1 has extra parenthesis at the end. The boolean expression in the for loop in line 3 is incorrect. Line 4 has a missing semicolon at the end. All such errors are due to the fact the function does not abide by the syntax of the C++ language grammar.

Semantic Analysis

Consider the English language sentence “He wrote the computer”. The sentence is syntactically correct but semantically wrong. The meaning of the sentence is incorrect; one does not “write” a computer. Issues related to meaning fall under the heading of *semantic analysis*. The following C++ function has semantic errors. The type of the local variable **sum** has not been declared. The returned value does not match the return value type of the function (**int***). The function is syntactically correct.

```
int* foo(int i, int j)
{
    for(k=0; i < j; j++) if( i < j-
        2 )
        sum = sum+i
    return sum;
}
```

Role of the Parser

Not all sequences of tokens are program. Parser must distinguish between valid and invalid sequences of tokens. What we need is an expressive way to describe the syntax of programs and an acceptor mechanism that determines if input token stream satisfies the syntax of the programming language. The acceptor mechanism determines if input token stream satisfies the syntax of a programming language.

Parsing is the process of discovering a *derivation* for some sentence of a language. The mathematical model of syntax is represented by a grammar G . The language generated by the grammar is indicated by $L(G)$. Syntax of most programming languages can be represented by *Context Free Grammars* (CFG).

A CFG is a four tuple $G=(S,N,T,P)$

1. S is the *start symbol*
2. N is a set of *non-terminals*
3. T is a set of *terminals*
4. P is a set of *productions*

Why aren't Regular Expressions used to represent syntax? The reasons is that regular languages do not have enough power to express syntax of programming languages. Moreover, finite automaton can't remember number of times it has visited a particular state.

Consider the following example of CFG

SheepNoise ? *SheepNoise* baa |
baa

This CFG defines the set of noises sheep make. We can use the *SheepNoise* grammar to create sentences of the language. We use the productions as rewriting rules

<i>Rule</i>	<i>Sentential Form</i>
-	<i>SheepNoise</i>
1	<i>SheepNoise</i> <u>baa</u>
1	<i>SheepNoise</i> <u>baa baa</u>
2	<u>baa baa baa</u>

While it is cute, this example quickly runs out intellectual steam. To explore uses of CFGs, we need a more complex grammar. Consider the grammar for arithmetic expressions:

1	<i>expr</i>	?	<i>expr op expr</i>
2			<u>num</u>
3			<u>id</u>
4	<i>op</i>	?	+
5			-
6			*
7			/

Grammar rules in a similar form were first used in the description of the Algol-60 programming language. The syntax of C, C++ and Java is derived heavily from Algol-60.

The notation was developed by John Backus and adapted by Peter Naur for the Algol-60 language report; thus the term Backus-Naur Form (BNF)

Let us use the expression grammar to derive the sentence

$$x - 2 * y$$

Rule	Sentential Form
-	<i>expr</i>
1	<i>expr op expr</i>
2	<id, <u>x</u> > op <i>expr</i>
5	<id, <u>x</u> > - <i>expr</i>
1	<id, <u>x</u> > - <i>expr op expr</i>
2	<id, <u>x</u> > - <num, <u>2</u> > op <i>expr</i>
6	<id, <u>x</u> > - <num, <u>2</u> > . <i>expr</i>
3	<id, <u>x</u> > - <num, <u>2</u> > . <id, <u>y</u> >

Such a process of rewrites is called a *derivation* and the process of discovering a derivation is called *parsing*. At each step, we choose a non-terminal to replace. Different choices can lead to different derivations.

Two derivations are of interest

1. *Leftmost*: replace leftmost non-terminal (NT) at each step
2. *Rightmost*: replace rightmost NT at each step

The example on the preceding slides was *leftmost derivation*. There is also a *rightmost* derivation. In both cases we have

$$expr \quad ? \quad * \quad \underline{id} - \underline{num} \quad \underline{id}$$

The two derivations produce different *parse trees*. The parse trees imply different evaluation orders!

Lecture 12

Parse Trees

The derivations can be represented in a tree-like fashion. The interior nodes contain the non-terminals used during the derivation

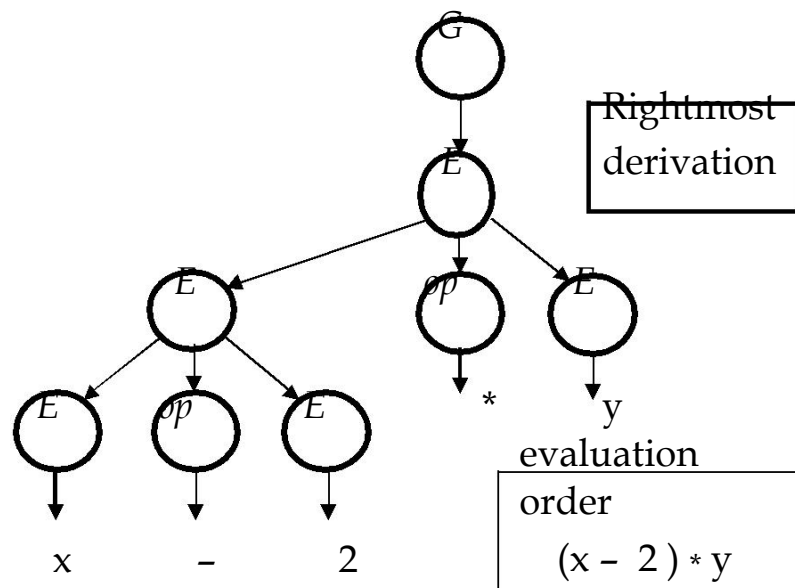
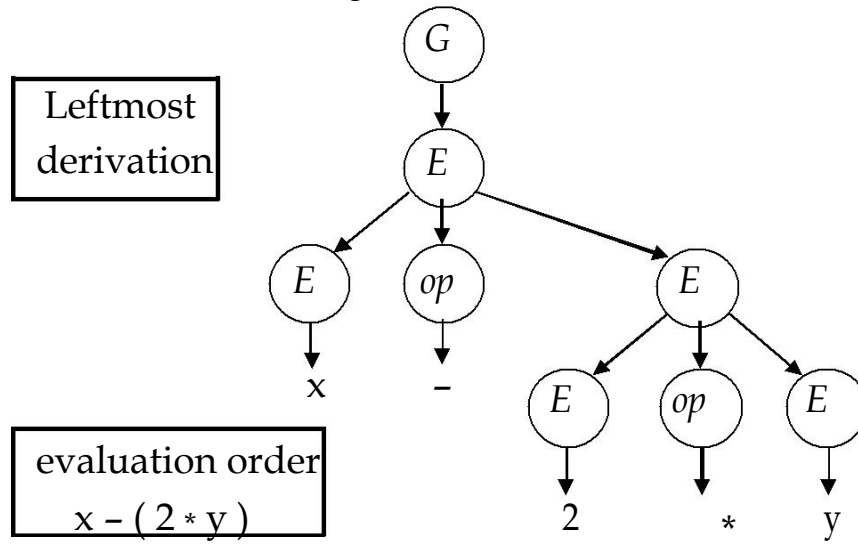

Precedence

These two derivations point out a problem with the grammar. It has no notion of *precedence*, or implied order of evaluation. The normal arithmetic rules say that multiplication has higher precedence than subtraction. To add precedence, create a non-terminal for each *level of precedence*. Isolate corresponding part of grammar to force parser to recognize high precedence sub-expressions first. Here is the revised grammar:

	1	<i>Goal</i>	?	<i>expr</i>	
level two	{	2	<i>expr</i>	?	<i>expr + term</i>
		3			<i>expr - term</i>
		4			<i>term</i>
level one	{	5	<i>term</i>	?	<i>term . factor</i>
		6			<i>term / factor</i>
		7			<i>factor</i>
	8	<i>factor</i>	?	<i>number</i>	
	9			<i>Id</i>	

This grammar is larger and requires more rewriting to reach some of the terminal symbols. But it encodes expected precedence. Let's see how it parses

$$x - 2 * y$$

<i>Rule</i>	<i>Sentential Form</i>
-	<i>Goal</i>
1	<i>Expr</i>
3	<i>expr - term</i>
5	<i>expr - term . factor</i>
9	<i>expr - term . <id,y></i>
7	<i>expr - factor . <id,y></i>
8	<i>expr - <num,2> . <id,y></i>
4	<i>term - <num,2> . <id,y></i>
7	<i>factor - <num,2> . <id,y></i>
9	<i><id,x> - <num,2> . <id,y></i>

This produces same parse tree under leftmost and rightmost derivations

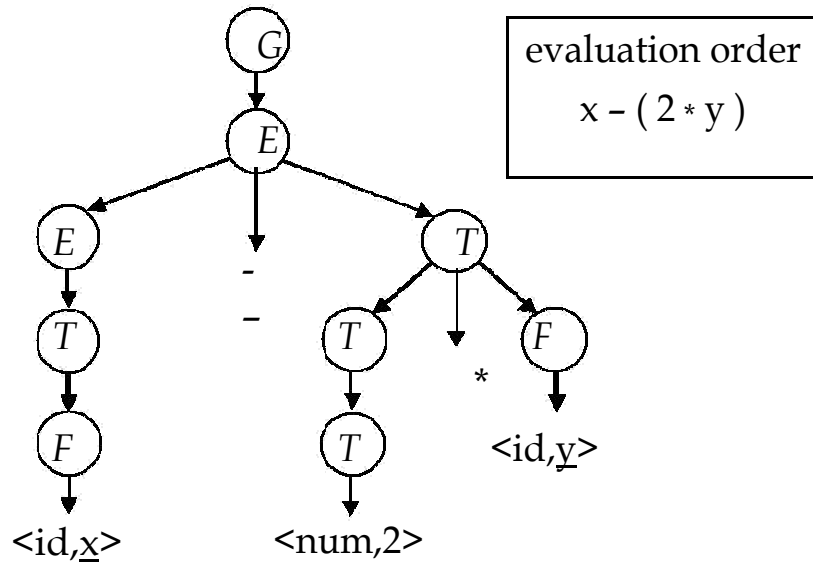

Both leftmost and rightmost derivations give the *same expression* because the grammar directly encodes the desired precedence.

Ambiguous Grammars

If a grammar has more than one leftmost derivation for a single sentential form, the grammar is *ambiguous*. The leftmost and rightmost derivations for a sentential form may differ, even in an *unambiguous* grammar. Let's consider the classic if-then-else example

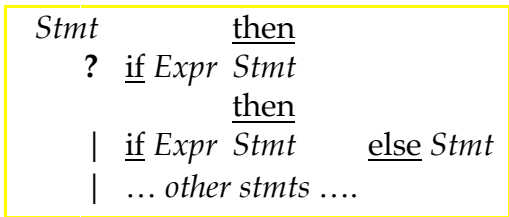

The following sentential form has two derivations:

if *E*₁ then if *E*₂ then *S* else *S*₂

Production 1,
 then Production 2:
 if E_1 then
 if E_2 then S_1
 else S_2

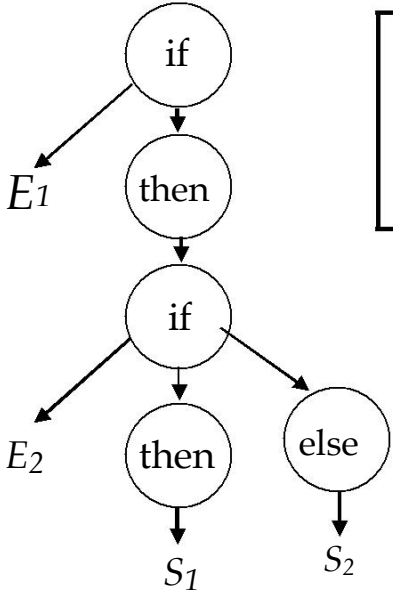
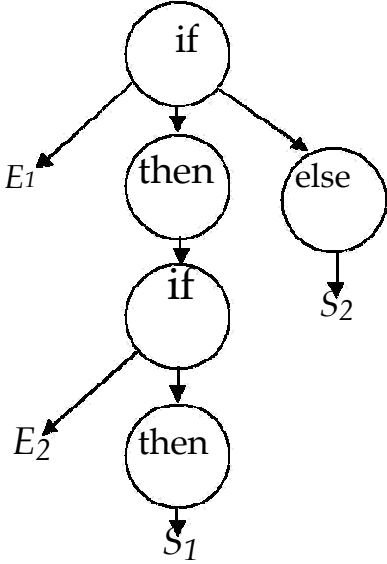

Production 2,
 then Production
 1:
 if E_1 then
 if E_2 then S_1
 else S_2

The convention in most programming languages is to match the else with the most recent if.

We can rewrite grammar to avoid generating the problem and match each else to innermost unmatched if:

1. *Stmt* ? If *E* then *Stmt*
2. | If *E* then *WithElse* else *Stmt*
3. | *Assignment*
4. *WithElse* ? If *E* then *WithElse* else *WithElse*
5. | *Assignment*

Let derive the following using the rewritten grammar:

if *E*₁ then if *E*₂ then *A*₁ else *A*₂

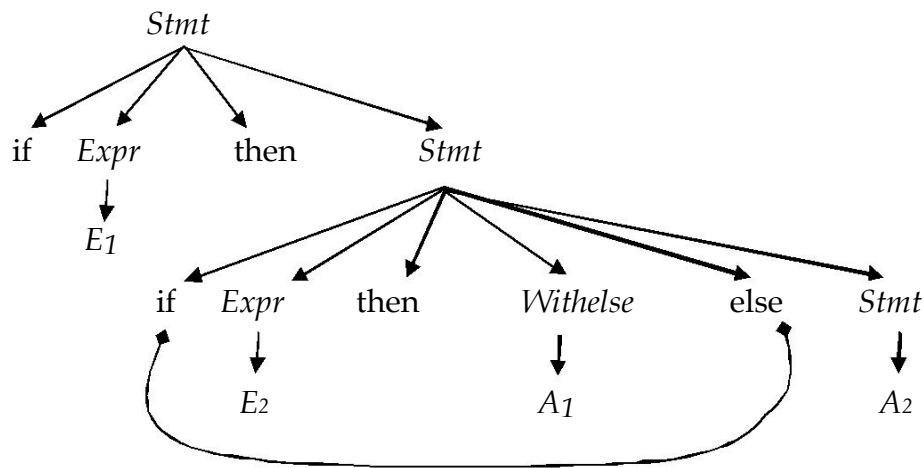

This binds the else controlling *A*₂ to inner if

Context-Free Grammars

We have been using the term context-free without explaining why such rules are in fact “free of context”. The simple reason is that non-terminals appear by themselves to the left of the arrow in context-free rules:

$A \rightarrow a$

The rule $A \rightarrow a$ says that *A* may be replaced by *a* anywhere, regardless of where *A* occurs. On the other hand, we could define a context as pair of strings β, γ , such that a rule would apply only if β occurs before and γ occurs after the non-terminal *A*. We would write this as

$\beta A \gamma \rightarrow \beta a \gamma$

Such a rule in which $\alpha \rightarrow \varepsilon$ is called a *context-sensitive* grammar rule. We

would write this as $\beta A \gamma \rightarrow \beta \alpha \gamma$

Such a rule in which $\alpha \rightarrow \varepsilon$ is called a *context-sensitive* grammar rule

Parsing Techniques

There are two primary parsing techniques: top-down and bottom- up.

Top-down parsers

A top-down parsers starts at the root of the parse tree and grows towards leaves. At each node, the parser picks a production and tries to match the input. However, the parser may pick the wrong production in which case it will need to backtrack. Some grammars are backtrack- free.

Bottom-up parsers

A bottom- up parser starts at the leaves and grows toward root of the parse tree. As input is consumed, the parser encodes possibilities in an internal state. The bottom- up parser starts in a state valid for legal first tokens. Bottom-up parsers handle a large class of grammars

Lecture 13

Top-Down Parser

A top-down parser starts with the root of the parse tree. The root node is labeled with the goal (start) symbol of the grammar. The top-down parsing algorithm proceeds as follows:

1. Construct the root node of the parse tree
2. Repeat until the fringe of the parse tree matches input string
 - a. At a node labeled A , select a production with A on its lhs
 - b. for each symbol on its rhs, construct the appropriate child
 - c. When a terminal symbol is added to the fringe and it does not match the fringe, backtrack

The key is picking right production in step a. That choice should be guided by the input string. Let's try parsing using this algorithm using the expression grammar.

$x - 2 * y$

P	Sentential Form	input
-	Goal	$x - 2 * y$
1	$expr$	$x - 2 * y$
2	$expr + term$	$x - 2 * y$
4	$term + term$	$x - 2 * y$
7	$factor + term$	$x - 2 * y$
9	$\langle id, x \rangle + term$	$x - 2 * y$
9	$\langle id, x \rangle + term$	$x - 2 * y$

This worked well except that "-" does not match "+". The parser made the wrong choice of production to use at step 2. The parser must backtrack and use a different production.

P	Sentential Form	input
-	Goal	$x - 2 * y$
1	$expr$	$x - 2 * y$
3	$expr - term$	$x - 2 * y$
4	$term - term$	$x - 2 * y$
7	$factor - term$	$x - 2 * y$
9	$\langle id, x \rangle - term$	$x - 2 * y$
9	$\langle id, x \rangle - term$	$x - 2 * y$

This time the “-” and “-” matched. We can advance past “-” to look at “2”.
Now, we need to expand “term”

<i>P</i>	<i>Sentential Form</i>	<i>input</i>
-	$\langle \text{id}, \underline{x} \rangle - \text{term}$	$\underline{x} - \tilde{2} * \underline{y}$
7	$\langle \text{id}, \underline{x} \rangle - \text{factor}$	$\underline{x} - \tilde{2} * \underline{y}$
9	$\langle \text{id}, \underline{x} \rangle - \langle \text{num}, 2 \rangle$	$\underline{x} - \tilde{2} * \underline{y}$
-	$\langle \text{id}, \underline{x} \rangle - \langle \text{num}, 2 \rangle$	$\underline{x} - \tilde{2} * \underline{y}$

The 2's match but the expansion terminated too soon because there is still unconsumed input and there are no non-terminals to expand in the sentential form → Need to backtrack.

<i>P</i>	<i>Sentential Form</i>	<i>input</i>
-	$\langle \text{id}, \underline{x} \rangle - \text{term}$	$\underline{x} - \tilde{2} * \underline{y}$
5	$\langle \text{id}, \underline{x} \rangle - \text{term} * \text{factor}$	$\underline{x} - \tilde{2} * \underline{y}$
7	$\langle \text{id}, \underline{x} \rangle - \text{factor} * \text{factor}$	$\underline{x} - \tilde{2} * \underline{y}$
8	$\langle \text{id}, \underline{x} \rangle - \langle \text{num}, 2 \rangle * \text{factor}$	$\underline{x} - \tilde{2} * \underline{y}$
-	$\langle \text{id}, \underline{x} \rangle - \langle \text{num}, 2 \rangle * \text{factor}$	$\underline{x} - \tilde{2} * \underline{y}$
-	$\langle \text{id}, \underline{x} \rangle - \langle \text{num}, 2 \rangle * \text{factor}$	$\underline{x} - \tilde{2} * \underline{y}$
-	$\langle \text{id}, \underline{x} \rangle - \langle \text{num}, 2 \rangle *$	
9	$\langle \text{id}, \underline{y} \rangle$	$\underline{x} - \tilde{2} * \underline{y}$
-	$\langle \text{id}, \underline{x} \rangle - \langle \text{num}, 2 \rangle *$	
-	$\langle \text{id}, \underline{y} \rangle$	$\underline{x} - \tilde{2} * \underline{y}$

This time the parser met with success. All of the input matched.

Left Recursion

Consider another possible parse:

<i>P</i>	<i>Sentential Form</i>	<i>input</i>
-	<i>Goal</i>	$\underline{x} - \tilde{2} * \underline{y}$
1	<i>expr</i>	$\underline{x} - \tilde{2} * \underline{y}$
2	<i>expr + term</i>	$\underline{x} - \tilde{2} * \underline{y}$
2	<i>expr + term + term</i>	$\underline{x} - \tilde{2} * \underline{y}$
2	<i>expr + term + term + term</i>	$\underline{x} - \tilde{2} * \underline{y}$
2	<i>expr + term + term + term + ...</i>	$\underline{x} - \tilde{2} * \underline{y}$

Parser is using productions but no input is being consumed.

Top-down parsers cannot handle left-recursive grammars. Formally, a grammar is left recursive if $\exists A \in NT$ such that a derivation $A \Rightarrow^* A \alpha$, for some string $\alpha \in (NT \cup T)^*$.

Our expression grammar is left recursive. This can lead to non-termination in a top-down parser. Non-termination is bad in any part of a compiler! For a top-down parser, any recursion must be a *right recursion*. We would like to convert left recursion to right

To remove left recursion, we can transform the grammar. Consider a grammar fragment:

$$A \rightarrow A\alpha \mid \beta$$

Where neither α nor β starts with A . We can rewrite this as:

$$A \rightarrow \beta A'$$

$$A' \rightarrow \alpha A' \mid \epsilon$$

where A' is a new non-terminal. This grammar accepts the same language but uses only right recursion. The expression grammar we have been using contains two cases of left-recursion. Applying the transformation yields

$$\begin{array}{l} \text{expr} \quad ? \quad \text{term expr}' \\ \text{expr}' \quad ? \quad + \text{term expr}' \\ \quad \quad | \quad - \text{term expr}' \\ \\ \text{term} \quad ? \quad \text{factor term}' \\ \text{term}' \quad ? \quad * \text{factor term}' \\ \quad \quad | \quad / \text{factor} \\ \quad \quad | \quad \text{term}' \\ \quad \quad | \quad \epsilon \end{array}$$

These fragments use only right recursion. They retain the original left associativity. A top-down parser will terminate using them.

Predictive Parsing

If a top down parser picks the wrong production, it may need to backtrack. Alternative is to *look-ahead* in input and use context to pick the production to use correctly. How much look-ahead is needed? In general, an arbitrarily large amount of look-ahead symbols are required.. Fortunately, large classes of CFGs can be parsed with limited lookahead. Most programming languages constructs fall in those subclasses

The basic idea in predictive parsing is: given $A \rightarrow \alpha \mid \beta$, the parser should be able to choose between α and β . To accomplish this, the parser needs FIRST and FOLLOW sets.

Definition: FIRST sets: for some rhs $\alpha \in G$, define $\text{FIRST}(\alpha)$ as the set of tokens that appear as the first symbol in some string that derives from α . That is, $x \in \text{FIRST}(\alpha)$ iff $\alpha \Rightarrow^* x\gamma$, for some γ .

Lecture 14

The LL(1) Property

If $A \rightarrow \alpha$ and $A \rightarrow \beta$ both appear in the grammar, we would like

$$\text{FIRST}(\alpha) \cap \text{FIRST}(\beta) = \emptyset$$

Predictive parsers accept LL(k) grammars. The two LL stand for Left-to-right scan of input, left-most derivation. The k stands for number of look-ahead tokens of input. The LL(1) Property allows the parser to make a correct choice with a look-ahead of exactly *one symbol*! What about ϵ -productions? They complicate the definition of LL(1).

If $A \rightarrow \alpha$ and $A \rightarrow \beta$ and $\epsilon \in \text{FIRST}(\alpha)$, then we need to ensure that $\text{FIRST}(\beta)$ is disjoint from $\text{FOLLOW}(A)$, too.

Definition: $\text{FOLLOW}(A)$ is the set of all words in the grammar that can legally appear after an A .

For a non-terminal X , $\text{FOLLOW}(X)$ is the set of symbols that might follow the derivation of X . Define $\text{FIRST}^+(A)$ as $\text{FIRST}(A) \cup \text{FOLLOW}(A)$, if $\epsilon \in \text{FIRST}(A)$, otherwise. Then a grammar is LL(1) iff $A \rightarrow \alpha$ and $A \rightarrow \beta$ implies

$$\text{FIRST}^+(\alpha) \cap \text{FIRST}^+(\beta) = \emptyset$$

Given a grammar that has the LL(1) property, we can write a simple routine to recognize each lhs. The code is simple and fast.

Consider

$A \rightarrow \beta_1 | \beta_2 | \beta_3,$

which satisfies the LL(1) property $\text{FIRST}^+(\alpha) \cap \text{FIRST}^+(\beta) = \emptyset$

```
/* find an A */
if(token ∈ FIRST(β1))
  find a β1 and return true
else if(token ∈ FIRST(β2))
  find a β2 and return true
if(token ∈ FIRST(β3))
  find a β3 and return true
else error and return false
```

Grammar with the LL(1) property are called *predictive grammars* because the parser can “predict” the correct expansion at each point in the parse. Parsers that capitalize on the LL(1) property are called *predictive parsers*. One kind of predictive parser is the *recursive descent* parser.

Recursive Descent Parsing

Consider the right-recursive expression grammar

1	<i>Goal</i>	?	<i>expr</i>
2	<i>expr</i>	?	<i>term expr'</i>
3	<i>expr'</i>	?	<i>+ term expr'</i>
4			<i>- term expr'</i>
5			ϵ
6	<i>term</i>	?	<i>factor term'</i>
7	<i>term'</i>	?	<i>* factor term'</i>
8			<i>/ factor term'</i>
9			ϵ
10	<i>factor</i>	?	<u><i>number</i></u>
11			<u><i>id</i></u>
12			<i>(expr)</i>

This leads to a parser with six mutually recursive routines: *goal*, *expr*, *exprime*, *term*, *terprime* and *factor*. Each recognizes one non-terminal (NT) or terminal (T). The term *descent* refers to the direction in which the *parse tree* is built. Here are some of these routines written as functions:

```
Goal() {
    token = next_token();
    if(Expr() == true && token == EOF)
        next compilation step
    else {
        report syntax error;
        return false;
    }
}
Expr()
{
    if(Term() == false)
        return false;
    else
        return Exprime();
}
Exprime() {
    token_type op = next_token(); if( op ==
    PLUS || op == MINUS ) {
        if(Term() == false)
            return false;
```

```

        else
            return Eprime();
    }
}

```

Functions for other non-terminals Term, Factor and Tprime follow the same pattern.

Recursive Descent in C++

This form of the routines is too procedural. Moreover, there is no convenient way to build the parse tree. We can use C++ to code the recursive descent parser in an object oriented manner. We associate a C++ class with each non-terminal symbol. An instantiated object of a non-terminal class contains pointer to the parse tree. Here is the C++ code for the non-terminal classes:

```

class NonTerminal {
public:
    NonTerminal(Scanner* sc)
    {
        s = sc; tree = NULL;
    }
    virtual ~NonTerminal(){}
    virtual bool isPresent()=0;
    TreeNode* AST(){
        return tree;
    }

protected:
    Scanner
    * s;
    TreeNode* tree;
}

class Expr:public NonTerminal
{
public:
    Expr(Scanner* sc): NonTerminal(sc){ } virtual
    bool isPresent();
}

class Eprime:public NonTerminal {
public:
    Eprime(Scanner* sc, TreeNode* t): NonTerminal(sc)

```



```

    {
        exprSofar = t;
    }
    virtual bool isPresent();
protected:
    TreeNode* exprSofar;
}

class Term:public NonTerminal
{
public:
    Term(Scanner* sc): NonTerminal(sc){ } virtual bool
    isPresent();
}

class Tprime:public NonTerminal { public:
    Tprime(Scanner* sc, TreeNode* t): NonTerminal(sc)
    {
        exprSofar = t;
    }
    virtual bool isPresent(); protected:
    TreeNode* exprSofar;
}

class Factor:public NonTerminal { public:
    Factor(Scanner* sc, TreeNode* t): NonTerminal(sc){ };

    virtual bool isPresent();
}

```

Lecture 15

Let's consider the implementation of the C++ classes for the non-terminals. We start with

Expr.

```
bool Expr::isPresent()
{
    Term* op1 = new Term(s);
    if(!op1->isPresent())
        return false;
    tree = op1->AST();
    Eprime* op2 = new Eprime(s, tree);
    if(op2->isPresent())
        tree = op2->AST();
    return true;
}

bool Eprime::isPresent()
{
    int op=s->nextToken();
    if(op==PLUS || op==MINUS){
        s->advance();
        Term* op2=new Term(s);
        if(!op2->isPresent())
            syntaxError(s);
        TreeNode* t2=op2->AST();
        tree = new TreeNode(op,exprSofar,t2);
        Eprime* op3 = new Eprime(s, tree);
        if(op3->isPresent())
            tree = op3->AST();
        return true;
    }
    else return false;
}

bool Term::isPresent()
{
    Factor* op1 = new Factor(s);
    if(!op1->isPresent())
        return false;
    tree = op1->AST();
    Tprime* op2 = new Tprime(s, tree);
    if(op2->isPresent())
        tree = op2->AST();
    return true;
}
```

```

bool Tprime::isPresent()
{
    int op=s->nextToken();
    if(op == MUL || op == DIV){
        s->advance();
        Factor* op2=new Factor(s);
        if(!op2->isPresent())
            syntaxError(s);
        TreeNode* t2=op2->AST();
        tree = new TreeNode(op,exprSofar,t2);
        Tprime* op3 = new Tprime(s, tree);
        if(op3->isPresent())
            tree = op3->AST();
        return true;
    }
    else return false;
}
bool Factor::isPresent()
{
    int op=s->nextToken();
    if(op == ID || op == NUM)
    {
        tree = new TreeNode(op,s->tokenValue());
        s->advance();
        return true;
    }
    if( op == LPAREN ){
        s->advance();
        Expr* opr = new Expr(s);
        if(!opr->isPresent() )
            syntaxError(s);
        if(s->nextToken() != RPAREN)
            syntaxError(s);
        s->advance();
        tree = opr->AST();
        return true;
    }
    return false;
}

```

Lecture 16

Here is the output trace for the expression: $2+4*6$

```
>> Expr::isPresent()
  >> Term::isPresent()
    >> Factor::isPresent() token: 2
      (257)
    << Factor::isPresent() return true
    >> Tprime::isPresent()
      token: + (267)
    << Tprime::isPresent() return false
  << Term::isPresent() return true
  >> Eprime::isPresent()
    token: + (267)
  >> Term::isPresent()
    >> Factor::isPresent() token: 4
      (257)
    << Factor::isPresent() return true >>
  Tprime::isPresent()
    token: * (269)
    >> Factor::isPresent() token: 6
      (257)
    << Factor::isPresent() return true
    >> Tprime::isPresent()
      token: (0)
    << Tprime::isPresent() return false
  << Tprime::isPresent() return true
  << Term::isPresent() return true
  >> Eprime::isPresent()
    token: (0)
  << Eprime::isPresent() return false
  << Eprime::isPresent() return true
  << Expr::isPresent() return true
```

** AST ** ($2+(4*6)$)

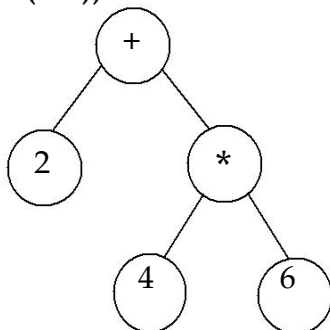

Non-recursive Predictive Parsing

It is possible to build a non-recursive predictive parser. This is done by maintaining an explicit stack and using a table. Such a parser is called a table-driven parser. The non-recursive LL(1) parser looks up the production to apply by looking up a parsing table. The LL(1) table has one dimension for current non-terminal to expand and another dimension for next token. Each table cell contains one production.

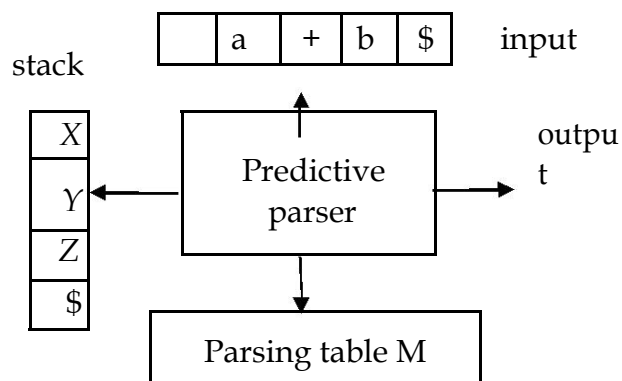

Consider the expression grammar

1	E	?	TE'
2	E'	?	$+TE'$
3			ϵ
4	T	?	FT'
5	T'	?	$*FT'$
6			ϵ
7	F	?	(E)
8			<u>id</u>

Using the table construction algorithm that will be discussed later, we have the predictive parsing table

	<u>id</u>	+	*	()	\$
E	$E ? TE'$			$E ? TE'$		
E'		$E' ? +TE'$			$E' ? \epsilon ? \epsilon$	
T				$T ? FT'$		
T'		$T' ? \epsilon$	$T' ? *FT'$		$T' ? \epsilon ? \epsilon$	
F	$F ? id$			$F ? (E)$		

The rows are non-terminals and the columns are the terminals of the expression grammar. The predictive parser uses an explicit stack to keep track of pending non-terminals. It can thus be implemented without recursion.

LL(1) Parsing Algorithm

The *input buffer* contains the string to be parsed; \$ is the end-of-input marker. The *stack* contains a sequence of grammar symbols. Initially, the stack contains the start symbol of the grammar on the top of \$. The parser is controlled by a program that behaves as follows:

The program considers X , the symbol on top of the stack, and a , the current input symbol. These two symbols, X and a determine the action of the parser. There are *three* possibilities.

1. $X = a = \$$, the parser halts and announces successful completion.
2. $X = a \neq \$$ the parser pops X off the stack and advances input pointer to next input symbol.
3. If X is a non-terminal, the program consults entry $M[X,a]$ of parsing table M .
 - a. If the entry is a production $M[X,a] = \{X \rightarrow UVW\}$, the parser replaces X on top of the stack by WVU (with U on top). As output, the parser just prints the production used: $X \rightarrow UVW$. However, any other code could be executed here.
 - b. If $M[X,a] = \text{error}$, the parser calls an error recovery routine

Example: let's parse the input string

id+idid

using the non-recursive LL(1) parser

Stack	Input	Output
\$E	<u>id</u> + <u>id</u> id\$	
\$E' T	<u>id</u> + <u>id</u> id\$	E ? TE'
\$E' T' F	<u>id</u> + <u>id</u> id\$	T ? FT'
\$E' T		
' <u>id</u>	<u>id</u> + <u>id</u> id\$	F ? <u>id</u>
\$E'		
T'	+ <u>id</u> <u>id</u> \$	
\$E'	+ <u>id</u> <u>id</u> \$	T' ? ε
\$E' T +	+ <u>id</u> <u>id</u> \$	E' ? +TE'
\$E' T	<u>id</u> <u>id</u> \$	
\$E' T' F	<u>id</u> <u>id</u> \$	T ? FT'
\$E'		
T' <u>id</u>	<u>id</u> <u>id</u> \$	F ? <u>id</u>
\$E'		
T'	. <u>id</u> \$	
\$E' T' F.	<u>id</u> \$	T ? .FT'
\$E' T' F	<u>id</u> \$	
\$E' T		
' <u>id</u>	<u>id</u> \$	F ? <u>id</u>
\$E'		
T'	\$	
\$E'	\$	T' ? ε
\$	\$	E' ? ε

Lecture 17

Note that productions output are tracing out a *leftmost derivation*. The grammar symbols on the stack make up *left-sentential forms*.

LL(1) Table Construction

Top-down parsing expands a parse tree from the start symbol to the leaves. It always expands the leftmost non-terminal. Consider the state

$S \rightarrow^* \beta A \gamma$

with b the next token and we are trying to match $\beta b \gamma$. There are two possibilities

1. b belongs to an expansion of A . Any $A \rightarrow^* \alpha$ can be used if b can start a string derived from $\tilde{\alpha}$. In this case we say that $b \in \text{FIRST}(\alpha)$.
2. b does not belong to an expansion of A . Expansion of A is empty, i.e., $A \rightarrow^* \epsilon$ and b belongs an expansion of γ , e.g., $b\omega$. which means that b can appear after A in a derivation of the form $S \rightarrow^* \beta A b \omega$. We say that $b \in \text{FOLLOW}(A)$.

Any $A \rightarrow^* \alpha$ can be used if α expands to ϵ . We say that $\epsilon \in \text{FIRST}(A)$ in this case.

Definition

$$\text{FIRST}(X) = \{ b \mid X \rightarrow^* b a \} \cup \{ \epsilon \mid X \rightarrow^* \epsilon \}$$

Lecture 18

Computing FIRST Sets

Here is the algorithm for computing the FIRST sets.

1. For all terminal symbols b ,

$$\text{FIRST}(b) = \{b\}$$

2. For all productions: $X \rightarrow A_1 \dots A_n$

Add $\text{FIRST}(A_1) - \{\epsilon\}$ to $\text{FIRST}(X)$, stop if $\epsilon \notin \text{FIRST}(A_1)$

Add $\text{FIRST}(A_2) - \{\epsilon\}$ to $\text{FIRST}(X)$, stop if $\epsilon \notin \text{FIRST}(A_2)$

.....

Add $\text{FIRST}(A_n) - \{\epsilon\}$ to $\text{FIRST}(X)$, stop if $\epsilon \notin \text{FIRST}(A_n)$

Add ϵ to $\text{FIRST}(X)$

This strategy is encoded in the following procedure

for each $a \in (T \cup \epsilon)$

$\text{FIRST}(a) \leftarrow \{a\}$

for each $A \in NT$

$\text{FIRST}(A) \leftarrow \emptyset$

while (FIRST sets are still changing)

 for each $A \rightarrow \beta_1 \beta_2 \dots \beta_k \in P$

$\text{FIRST}(A) \leftarrow \text{FIRST}(A) \cup (\text{FIRST}(\beta_1) - \{\epsilon\})$

$i \leftarrow 1$

 while ($\epsilon \in \text{FIRST}(\beta_i)$ and $i = k-1$)

$\text{FIRST}(A) \leftarrow \text{FIRST}(A) \cup (\text{FIRST}(\beta_{i+1}) - \{\epsilon\})$

$i \leftarrow i+1$

 if ($i == k$ and $\epsilon \in \text{FIRST}(\beta_k)$)

$\text{FIRST}(A) \leftarrow \text{FIRST}(A) \cup \{\epsilon\}$

Example : consider the expression grammar again

1	E	\rightarrow	TE'
2	E'	\rightarrow	$+TE'$
3		$ $	ϵ
4	T	\rightarrow	FT'
5	T'	\rightarrow	$*FT'$
6		$ $	ϵ
7	F	\rightarrow	(E)
8		$ $	<u>Id</u>

$$\begin{aligned}\text{FIRST}(\text{id}) &= \{ \text{id} \} \\ \text{FIRST}('(') &= \{ (\} \\ \text{FIRST}('+') &= \{ + \}\end{aligned}$$

$$\begin{aligned}\text{FIRST}(E) &= \{ \text{FIRST}(T) - \{ \epsilon \} \} \\ \text{FIRST}(T) &= \{ \text{FIRST}(F) - \{ \epsilon \} \} \\ \text{FIRST}(F) &= \{ \text{FIRST}('(') - \{ \epsilon \} \} = \{ (\}\end{aligned}$$

$$\text{FIRST}(F) = \{ '(' \} + \{ \text{FIRST}(\text{id}) - \{ \epsilon \} \} = \{ (, \text{id} \}$$

$$\begin{aligned}\text{FIRST}(E') &= \{ +, \epsilon \} \\ \text{FIRST}(T') &= \{ *, \epsilon \}\end{aligned}$$

Thus,

$$\begin{aligned}\text{FIRST}(E) &= \text{FIRST}(T) = \text{FIRST}(F) = \{ (, \text{id} \} \\ \text{FIRST}(E') &= \{ +, \epsilon \} \\ \text{FIRST}(T') &= \{ *, \epsilon \}\end{aligned}$$

FOLLOW Sets

Definition:

$$\text{FOLLOW}(X) = \{ b \mid S \Rightarrow^* \beta X b \}$$

Computing FOLLOW Sets:

1. Add \$ to FOLLOW(S) where S is the start non-terminal.
2. If there is a production $A \Rightarrow \alpha B \beta$, then everything in $\text{FIRST}(\beta) - \{ \epsilon \}$ is in FOLLOW(B).
3. If there is a production $A \Rightarrow \alpha B$, or $A \Rightarrow \alpha B \beta$, where $\epsilon \in \text{FIRST}(\beta)$ (i.e., $\beta \Rightarrow^* \epsilon$), then everything in FOLLOW(A) is in FOLLOW(B)

The following procedure encodes this strategy.

```

for each  $A \in NT$ 
    FOLLOW(A)  $\leftarrow \emptyset$ 
FOLLOW(S)  $\leftarrow \{\$ \}$ 
while ( FOLLOW sets are still changing)
    for each  $A \rightarrow \beta_1\beta_2\dots\beta_k \in P$ 
        FOLLOW( $\beta_k$ )  $\leftarrow$  FOLLOW( $\beta_k$ )  $\cup$  FOLLOW(A)
        T  $\leftarrow$  FOLLOW(A)
        for i  $\leftarrow$  k downto 2
            if ( $\epsilon \in \text{FIRST}(\beta_i)$ )
                FOLLOW( $\beta_{i-1}$ )  $\leftarrow$  FOLLOW( $\beta_{i-1}$ )  $\cup$  (FIRST( $\beta_i$ ) -  $\{\epsilon\}$ )  $\cup$  T
            else
                FOLLOW( $\beta_{i-1}$ )  $\leftarrow$  FOLLOW( $\beta_{i-1}$ )  $\cup$  FIRST( $\beta_i$ )
        T  $\leftarrow \emptyset$ 

```

Let's apply the algorithm to the expression grammar.

Put \$ in FOLLOW(E). By rule (2) applied to production $E \rightarrow (E)$, ')' is also in FOLLOW(E). Thus, FOLLOW(E) = {), \$}. By rule (3) applied to production $E \rightarrow T E'$, \$ and ')' are in FOLLOW(E'). Thus, FOLLOW(E) = FOLLOW(E') = {), \$}. Similarly, FOLLOW(T) = FOLLOW(T') = { +,), \$} and FOLLOW(F) = { +, .,), \$}

Lecture 19

LL(1) Table Construction

Here now is the algorithm to construct a predictive parsing table.

1. For each production $A \rightarrow \alpha$
 1. for each terminal a in $\text{FIRST}(\alpha)$, add $A \rightarrow \alpha$ to $M[A,a]$.
 2. If ϵ is in $\text{FIRST}(\alpha)$, add $A \rightarrow \alpha$ to $M[A,b]$ for each terminal b in $\text{FOLLOW}(A)$. If ϵ is in $\text{FIRST}(\alpha)$, and $\$$ is in $\text{FOLLOW}(A)$, add $A \rightarrow \alpha$ to $M[A,\$]$.
2. Make each undefined entry of M be error.

Let us apply the algorithm to the expression grammar. Since $\text{FIRST}(TE') = \text{FIRST}(T) = \{ (, \text{id} \}$, the production $E \rightarrow TE'$ cause $M[E,(]$ and $M[E,\text{id}]$ to get $E \rightarrow TE'$. The production $E' \rightarrow +TE'$ causes $M[E',+]$ to get $E' \rightarrow +TE'$. The production $E' \rightarrow \epsilon$ causes $M[E',)]$ and $M[E',\$]$ to get $E' \rightarrow \epsilon$ since $\text{FOLLOW}(E') = \{), \$ \}$. And so on. The final parsing table produced is:

	id	+	*	()	\$
E	$E \rightarrow TE'$			$E \rightarrow TE'$		
E'		$E' \rightarrow +TE'$			$E' \rightarrow \epsilon$	$E' \rightarrow \epsilon$
T	$T \rightarrow FT'$			$T \rightarrow FT'$		
T'		$T' \rightarrow \epsilon$	$T' \rightarrow *FT'$		$T' \rightarrow \epsilon$	$T' \rightarrow \epsilon$
F	$F \rightarrow \text{id}$			$F \rightarrow (E)$		

Left Factoring

Consider the grammar

$$\begin{aligned}
 E &\rightarrow T + E \mid T \\
 T &\rightarrow \text{int} \mid \text{int} T \mid (E)
 \end{aligned}$$

It is impossible to predict because for T , two productions start with int . For E , it

is not clear how to predict; the two productions start with the non-terminal T. A grammar must be *left factored* before use for predictive parsing. The procedure to left-factor a grammar is as follows:

If $\alpha \neq \epsilon$, replace all productions

$A \rightarrow \alpha\beta_1 \mid \alpha\beta_2 \mid \dots \mid \alpha\beta_n \mid \gamma$

with

$A \rightarrow \alpha Z \mid \gamma$

$Z \rightarrow \beta_1 \mid \beta_2 \mid \dots \mid \beta_n$

where Z is a new non-terminal

A graphical explanation:

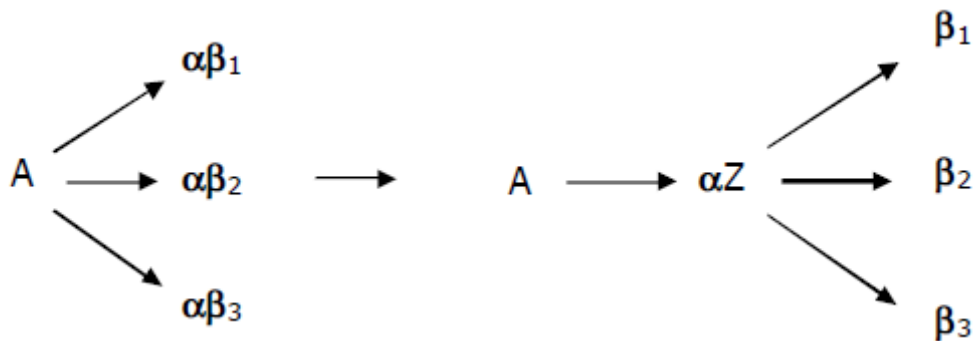

Example: consider following fragment of expression grammar

Factor \rightarrow id
 \mid id [ExprList]
 \mid id (ExprList)

After left factoring, the grammar becomes

Factor \rightarrow id Args
 Args \rightarrow [ExprList]
 \mid (ExprList)
 \mid ϵ

Given a CFG that does not meet the LL(1) condition, it is *un-decidable* whether or not an equivalent LL(1) grammar exists.

Lecture 20

Bottom-up Parsing

Bottom-up parsing is more general than top-down parsing. Bottom-up parsers handle a large class of grammars. It is the preferred method in practice. It is also called *LR* parsing; *L* means that tokens are read left to right and *R* means that the parser constructs a rightmost derivation. LR parsers do not need left-factored grammars. LR parsers can handle left-recursive grammars.

LR parsing *reduces* a string to the start symbol by inverting productions. A derivation consists of a series of rewrite steps

$$\begin{aligned} S &\Rightarrow \gamma_0 \Rightarrow \gamma_1 \Rightarrow \dots \Rightarrow \gamma_{n-1} \\ &\quad \Rightarrow \gamma_n \Rightarrow \text{sentence} \end{aligned}$$

Each γ_i is a sentential form. If γ contains only terminals, γ is a sentence in $L(G)$. If γ contains ≥ 1 nonterminals, γ is a sentential form. A bottom-up parser builds a derivation by working from input sentence back towards the start symbol S .

Consider the grammar

$$\begin{aligned} S &\rightarrow aABe \\ A &\rightarrow Abc \mid b \\ B &\rightarrow d \end{aligned}$$

The sentence `abcde` can be reduced to S :

abcde
aAbcd
e aAde
aABe S

These reductions, in fact, trace out the following right-most derivation in reverse:

$$\begin{aligned} S &\rightarrow aABe \\ &\rightarrow aAde \\ &\rightarrow aAbcde \\ &\rightarrow abcde \end{aligned}$$

$$S \rightarrow aBy \rightarrow a\gamma y \rightarrow xy$$

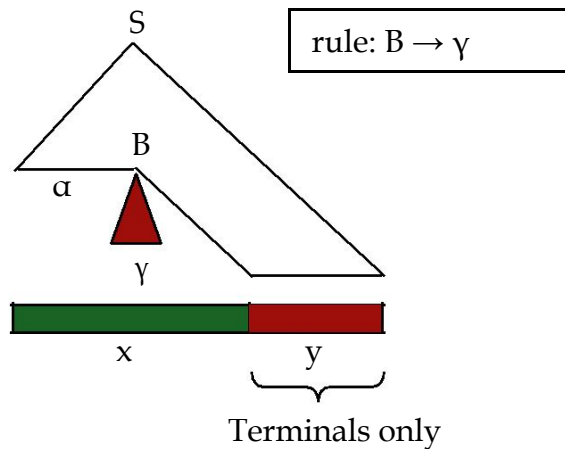

Consider the grammar

1. $E \rightarrow E + (E)$
2. $\quad \quad \quad | \underline{\text{int}}$

The bottom-up parse of the string $\text{int} + (\text{int}) + (\text{int})$ would be

$\text{int} + (\text{int}) + (\text{int})$
 $E + (\text{int}) + (\text{int}) E$
 $+ (E) + (\text{int})$
 $E + (\text{int})$
 $E + (E)$
 E

The consequence of an LR parser tracing a rightmost derivation in reverse is that given $\alpha\beta\gamma$ be a step of a bottom-up parse, assuming that next reduction is $A \rightarrow \beta$ then γ is a string of terminals. The reason is that $\alpha A \gamma \rightarrow \alpha\beta\gamma$ is a step in a rightmost derivation. This observation provides a strategy for building bottom up parsers: split the input string into two substrings. Right substring (a string of terminals) is as yet unexamined by parser and left substring has terminals and non-terminals. The dividing point is marked by a \blacktriangleright (the \blacktriangleright is not part of the string). Initially, all input is unexamined: $\blacktriangleright x_1 x_1 \dots x_n$.

Shift-Reduce Parsing

Bottom-up parsing uses only two kinds of actions:

1. Shift
2. Reduce

Shift moves ► one place to the right which shifts a terminal to the left string

$$E + (\blacktriangleright \text{int}) \Rightarrow E + (\text{int } \blacktriangleright)$$

In the *reduce* action, the parser applies an inverse production at the right end of the left string. If $E \rightarrow E + (E)$ is a production, then

$$E + (E + (E) \blacktriangleright) \Rightarrow E + (E \blacktriangleright)$$

Shift-Reduce Example

► int + (int) + (int) \$	shift
int ► + (int) + (int) \$	reduce $E \rightarrow \text{int}$
E ► + (int) + (int) \$	shift 3 times
E + (int ►) + (int) \$	reduce $E \rightarrow \text{int}$
E + (E ►) + (int) \$	shift
E + (E) ► + (int) \$	reduce $E \rightarrow E+(E)$
E ► + (int) \$	shift 3 times
E + (int ►) \$	reduce $E \rightarrow \text{int}$
E + (E ►) \$	shift
E + (E) ► \$	red $E \rightarrow E+(E)$
E ► \$	<u>accept</u>

Lecture 21

Shift-Reduce: The Stack

A stack can be used to hold the content of the left string. The Top of the stack is marked by the \blacktriangleright symbol. The shift action pushes a terminal on the stack.

Reduce pops zero or more symbols from the stack (production *rhs*) and pushes a non-terminal on the stack (production *lhs*)

Discovering Handles

A bottom-up parser builds the parse tree starting with its leaves and working toward its root. The upper edge of this partially constructed parse tree is called its *upper frontier*. At each step, the parser looks for a section of the upper frontier that matches right-hand side of some production. When it finds a match, the parser builds a new tree node with the production's left-hand non-terminal thus extending the frontier upwards towards the root. The critical step is developing an efficient mechanism that finds matches along the tree's current frontier.

Formally, the parser must find some substring β , of the upper frontier where

1. β is the right-hand side of some production $A \rightarrow \beta$, and
2. $A \rightarrow \beta$ is one step in right-most derivation of input stream

We can represent each potential match as a pair $\langle A \rightarrow \beta.k \rangle$, where k is the position on the tree's current frontier of the right-end of β . The pair $\langle A \rightarrow \beta.k \rangle$ is called the *handle* of the bottom-up parse.

Handle Pruning

A bottom-up parser operates by repeatedly locating handles on the frontier of the partial parse tree and performing reductions that they specify. The bottom-up parser uses a stack to hold the frontier. The stack simplifies the parsing algorithm in two ways.

First, the stack trivializes the problem of managing space for the frontier. To extend the frontier, the parser simply pushes the current input token onto the top of the stack. Second, the stack ensures that all handles occur with their right end at the top of the stack. This eliminates the need to represent handle's position.

Shift-Reduce Parsing Algorithm

push \$ onto stack

sym ←

nextToken()

repeat until (sym == \$ and the stack contains exactly Goal on top of \$) *if* a handle for $A \rightarrow \beta$ on top of stack

pop $|\beta|$ symbols off the
stack push A onto the
stack

else if (sym ≠ \$)

push sym onto stack sym

← nextToken() *else* /* no

handle, no input */

report error and halt

Lecture 22

Example: here is the bottom-up parser's action when it parses the expression grammar sentence

$$x - 2 \times y$$

(tokenized as id - num * id)

	word	Stack	Handle	Action
1	id	▶	- none -	<i>shift</i>
2	-	id ▶	<Factor → id,1>	<i>reduce</i>
3	-	Factor ▶	<Term → Factor,1>	<i>reduce</i>
4	-	Term ▶	<Expr → Term,1>	<i>reduce</i>
5	-	Expr ▶	- none -	<i>shift</i>
6	num	Expr - ▶	- none -	<i>shift</i>
7	×	Expr - num ▶	<Factor → num,3>	<i>reduce</i>
8	×	Expr - Factor ▶	<Term → Factor,3>	<i>shift</i>
9	×	Expr - Term ▶	- none -	<i>shift</i>
10	id	Expr - Term × ▶	- none -	<i>shift</i>
11	\$	Expr - Term × id ▶	<Factor → id,5>	<i>reduce</i>
12	\$	Expr - Term × Factor ▶	<Term → Term × Factor,5>	<i>reduce</i>
13	\$	Expr - Term ▶	<Expr → Expr - Term,3>	<i>reduce</i>
14	\$	Expr ▶	<Goal → Expr,1>	<i>reduce</i>
15	\$	Goal	- none -	<u><i>accept</i></u>

Handles

The handle-finding mechanism is the key to efficient bottom-up parsing. As it process an input string, the parser must find and track all potential handles. For example, every legal input eventually reduces the entire frontier to grammar's goal symbol. Thus,

<Goal → Expr,1> is a potential handle at the start of every parse. As the parser builds a derivation, it discovers other handles. At each step, the set of potential handles represent different suffixes that lead to a reduction. Each potential handle represent a string of grammar symbols that, if seen, would complete the right-hand side of some production.

For the bottom-up parse of the expression grammar string, we can represent the potential handles that the shift-reduce parser should track. Using the placeholder \bullet to represent top of the stack, there are nine handles:

	Handles
1	$\langle \text{Factor} \rightarrow \text{id} \bullet \rangle$
2	$\langle \text{Term} \rightarrow \text{Factor} \bullet \rangle$
3	$\langle \text{Expr} \rightarrow \text{Term} \bullet \rangle$
4	$\langle \text{Factor} \rightarrow \text{num} \bullet \rangle$
5	$\langle \text{Term} \rightarrow \text{Factor} \bullet \rangle$
6	$\langle \text{Factor} \rightarrow \text{id} \bullet \rangle$
7	$\langle \text{Term} \rightarrow \text{Term} \times \text{Factor} \bullet \rangle$
8	$\langle \text{Expr} \rightarrow \text{Expr} - \text{Term} \bullet \rangle$
9	$\langle \text{Goal} \rightarrow \text{Expr} \bullet \rangle$

This notation shows that the second and fifth handles are identical, as are first and sixth. It also create a way to represent the potential of discovering a handle in future. Consider the parser's state in step 6: The parser has recognized $\text{Expr} -$. Using the stack-relative notation, we can represent the parser's state as $\text{Expr} \rightarrow \text{Expr} - \bullet \text{Term}$. The parser has already recognized an Expr and a $-$. If the parser reaches a state where it shifts a Term on top of Expr and $-$, it will complete the handle $\text{Expr} \rightarrow \text{Expr} - \text{Term} \bullet$. How many potential handles must the parser recognize? The right-hand side of each production can have a placeholder at its start, at its end and between any two consecutive symbols.

$\text{Expr} \rightarrow \bullet \text{Expr} - \text{Term}$
 $\text{Expr} \rightarrow \text{Expr} \bullet - \text{Term}$
 $\text{Expr} \rightarrow \text{Expr} - \bullet \text{Term}$
 $\text{Expr} \rightarrow \text{Expr} - \text{Term} \bullet$

If the right-hand side of a production has k symbols, it has $k + 1$ placeholder positions.

Lecture 23

Handles

The number of potential handles for the grammar is simply the sum of the lengths of the right-hand side of all the productions. The number of complete handles is simply the number of productions. These two facts lead to the critical insight behind LR parsers:

A given grammar generates a finite set of handles (and potential handles) that the parser must recognize

However, it is not a simple matter of putting the placeholder in right-hand side to generate handles. The parser needs to recognize the correct handle by different right contexts. Consider the parser's action at step 9.

	word	Stack	Handle	Action
9	×	Expr - Term ▶	- none -	<i>shift</i>
10	id	Expr - Term × ▶	- none -	<i>shift</i>
11	\$	Expr - Term × id ▶	<Factor → id,5>	<i>reduce</i>
12	\$	Expr-Term × Factor ▶	<Term → Term × Factor,5 >	<i>reduce</i>
13	\$	Expr - Term ▶	<Expr → Expr - Term,3>	<i>reduce</i>
14	\$	Expr ▶	<Goal → Expr,1>	<i>reduce</i>
15	\$	Goal	- none -	<u><i>accept</i></u>

The frontier is Expr - Term, suggesting a handle <Expr → Expr - Term>•. However, the parser decides to extend the frontier by shifting × on to the stack rather than reducing frontier to Expr. Clearly, this is the correct move for the parser. No potential handle contains Expr followed by ×. At step 9, the set of potential handles is

<Expr → Expr - Term•>
 <Term → Term• × Factor>
 <Term → Term• / Factor >

The next input symbol clearly matches the second choice. The parser needs a basis for deciding between first (reduce) and second (shift) choices:

<Expr \rightarrow Expr - Term•>
 <Term \rightarrow Term• \times Factor>

This requires more context than the parser has in the frontier (stack). To choose between reducing and shifting, the parser must recognize which symbols can occur to the right of Expr and Term in valid phrases.

LR(1) Parsers

The LR(1) parsers can recognize precisely those languages in which one-symbol lookahead suffices to determine whether to shift or reduce. The LR(1) construction algorithm builds a handle-recognizing DFA. The parsing algorithm uses this DFA to recognize handles and potential handles on the parse stack

Parsing DFA

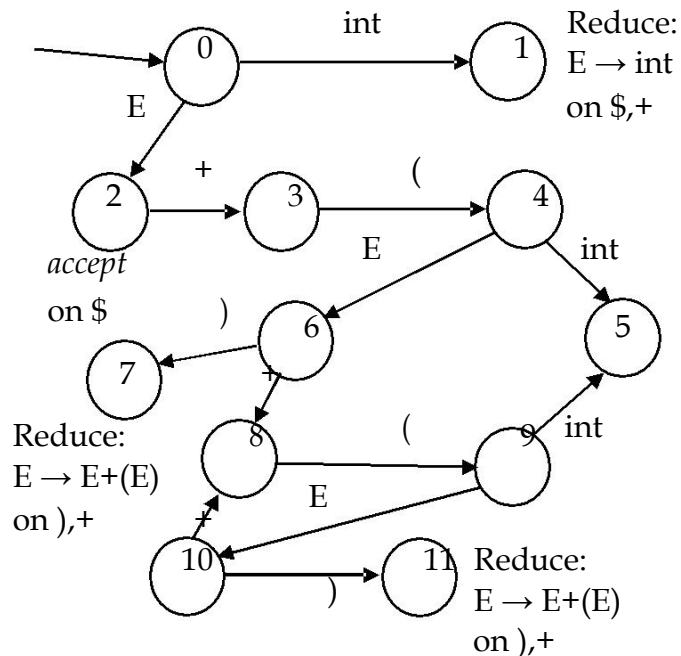

In order to remember the state the DFA goes into on a symbol, the parser stores the DFA state in the stack along with the symbol. Initial entry in the stack will be '<dummy,0>'.

Parsers represent DFA as a 2D table. The rows correspond to DFA states and columns correspond to terminals and non-terminals. The columns with

terminals and the rows form the *action table* while the columns with non-terminals and rows are called the *goto table*. It is customary to show these tables together.

Building LR(1) Tables

To construct *Action* and *Goto* tables, the LR(1) parser generator builds a model of handle-recognizing DFA. The model is used to fill in the tables. The LR(1)-table construction needs a concrete representation for the handles and their associated lookahead symbols. We call this representation an *LR(1) item*.

Lecture 24

An LR(1) item is a pair $[X \rightarrow \alpha \bullet \beta, a]$ where $X \rightarrow \alpha \beta$ is a production and $a \in T$ (terminals) is look-ahead symbol. The model uses a set of LR(1) items to represent each parser state. The model is called the *canonical collection (CC) of set of LR(1) items*.

Canonical Collection

Each set in CC represents a state in the eventual parser DFA. The construction of CC begins by building a model of parser's initial state. The initial state consists of the set of LR(1) items that represent the parser's initial state, along with any items that must also hold in the initial state. To simplify the task of building this initial state, the construction requires that the grammar have a unique goal symbol. The convention is to add a new start symbol S to grammar and a production

$$S \rightarrow E$$

This leads to the augmented grammar

$$\begin{aligned} S &\rightarrow E \\ E &\rightarrow E + (E) \mid \underline{\text{int}} \end{aligned}$$

The Closure Procedure

The item $[S \rightarrow \bullet E, \$]$ describes the parser's initial state. It represents a configuration in which recognizing S followed by \$ would be a valid parse. This item, i.e., $[S \rightarrow \bullet E, \$]$ becomes the core of the first state in CC, labeled I_0 . If the grammar has several distinct productions for the start symbol, each of them generates an item in this initial core of I_0 . The procedure *closure* does this.

$$\begin{aligned} &\text{closure}(s) \\ &= \text{repeat} \\ &\quad \text{for each } [X \rightarrow \alpha \bullet Y \beta, a] \in s \\ &\quad \text{for each production } Y \rightarrow \alpha \\ &\quad \text{for each } b \in \text{FIRST}(\beta a) \\ &\quad \quad s \leftarrow s \cup [Y \rightarrow \bullet \gamma, \\ &\quad \quad b] \text{ until } s \text{ is unchanged} \end{aligned}$$

Let's apply this procedure to the augmented grammar.

The first set is $I_0 = \text{closure}(\{[S \rightarrow \bullet E, \$]\})$. Equating the terms in the

procedure, $s = \{[S \rightarrow \bullet E, \$], [X \rightarrow \alpha \bullet Y\beta, a] \Leftrightarrow [S \rightarrow \bullet E, \$], X = S, \alpha = \epsilon, Y = E, \beta = \epsilon, a = \$, Y \rightarrow \gamma \cup E \rightarrow E + (E) \text{ and } E \rightarrow \text{int}\}$
 $\text{FIRST}(\beta a) = \text{FIRST}(\epsilon \$) = \$$.

This leads to expansion of s .

$$s = \{ [S \rightarrow \bullet E, \$] \} \cup \{ [E \rightarrow \bullet E + (E), \$] \} \cup \{ [E \rightarrow \bullet \text{int}, \$] \} = \\ \{ [S \rightarrow \bullet E, \$], [E \rightarrow \bullet E + (E), \$], [E \rightarrow \bullet \text{int}, \$] \}$$

The set s changed so we repeat. The item $[S \rightarrow \bullet E, \$]$ is already processed. The for loop considers $[X \rightarrow \alpha \bullet Y\beta, a] \Leftrightarrow [E \rightarrow \bullet E + (E), \$]$, which leads to the match up $X = E$,

$\alpha = \epsilon, Y = E, \beta = +(E), a = \$, Y \rightarrow \gamma \Leftrightarrow E \rightarrow E + (E), \Leftrightarrow E \rightarrow \text{int}$
 $\text{FIRST}(\beta a) = \text{FIRST}(\epsilon +(E)\$) = +$. The set s is extended

$$s = s \cup \{ [E \rightarrow \bullet E + (E), +] \} \cup \{ [E \rightarrow \bullet \text{int}, +] \}$$

Lecture 25

The set s changed so the repeat loop is executed again. This time, however, the item $[E \rightarrow \bullet \text{int}, \$/+]$ does not yield any more items because the dot is followed by the terminal int . The first set of items is

$$I_0 = \{ \begin{array}{l} [S \rightarrow \bullet E, \$], \\ [E \rightarrow \bullet E+(E), \$/+], \\ [E \rightarrow \bullet \text{int}, \$/+] \end{array} \}$$

Let's consider the rationale behind the *Closure* procedure. If $[A \rightarrow \beta \bullet C\delta, a] \in s$, then one potential completion for the left context is to find a string that reduces to C , followed by δa . This completion should cause a reduction to A , since it fills out the production's right-hand side ($C\delta$), and follows it with a valid look-ahead symbol. For a production

$C \rightarrow \gamma$, *closure* must insert ' \bullet ' before γ and add appropriate look-ahead symbols - all terminals that can appear as the initial symbol in δa . This includes every terminal in $\text{FIRST}(\delta)$. If $\epsilon \in \text{FIRST}(\delta)$, it also includes a , thus $\text{FIRST}(\delta a)$ in the algorithm.

The *goto* Procedure

The second critical step in the construction is to derive other parser states from I_0 . To accomplish this, we compute, for each state I_i and each grammar symbol y , the state that would arise if the parser recognized a y while in state I_i . A state s that contains

$[X \rightarrow \alpha \bullet y\beta, b]$ has a transition (*goto*) labeled y to the state that contains the items *goto*(s, y) where y can be terminal or a non-terminal.

$$\begin{array}{l} \textit{goto}(s, y) \\ m \leftarrow \{ \} \\ \text{for each item } [X \rightarrow \alpha \bullet y\beta, b] \in s \\ m \leftarrow m \cup \{ [X \rightarrow \alpha y \bullet \beta, b] \} \\ \text{return } \textit{closure}(m) \end{array}$$

Finite Automaton of Items

The LR(1) items are used as the states of a finite automaton (FA) that maintains information about the parsing stack and progress of a shift-reduce parser. The FA will start out as a nondeterministic finite automaton (NFA). A DFA can be constructed from this NFA using the subset construction, similar to one we used for lexical analysis.

Consider the NFA of LR(0) items, i.e., no look-ahead. What are the transitions of the NFA of LR(0) items? Consider the item $A \rightarrow \alpha \bullet \gamma$. Suppose γ begins with symbol X which may be a terminal (token) or non-terminal. The item can be written as $A \rightarrow \alpha \bullet X \eta$.

Then there is a transition on symbol X for state represented by item $A \rightarrow \alpha \bullet X \eta$ to state represented by item $A \rightarrow \alpha X \bullet \eta$. If X is a terminal, then this transition corresponds to a shift of X from input to top of parse stack.

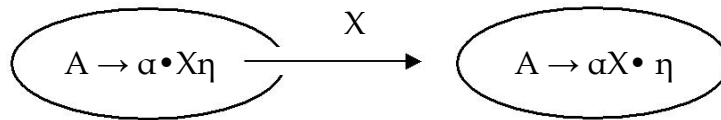

If X is a non-terminal, then the interpretation of this transition is more complex because non-terminals do not appear in input. In fact, such a transition will correspond to pushing of X onto the stack during the parse. But this can only occur during a reduction by the production $X \rightarrow \beta$. Such a reduction must be preceded by recognition of a β . The state given by $X \rightarrow \bullet \beta$ represents the beginning of this process (dot indicates we are about to recognize β). Then for every item $A \rightarrow \alpha \bullet X \eta$ we must add an ϵ -transition for every production $X \rightarrow \beta$.

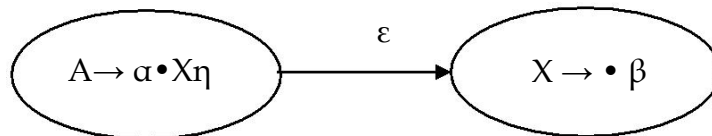

Lecture 26

The initial DFA state I_0 we computed is the ϵ -closure of the set consisting of item

$$S \rightarrow \bullet E$$

Recall the stage in the closure

$$s = \{ [S \rightarrow \bullet E, \$], [E \rightarrow \bullet E + (E), \$], [E \rightarrow \bullet \text{int}, \$] \}$$

The NFA states and transitions required are

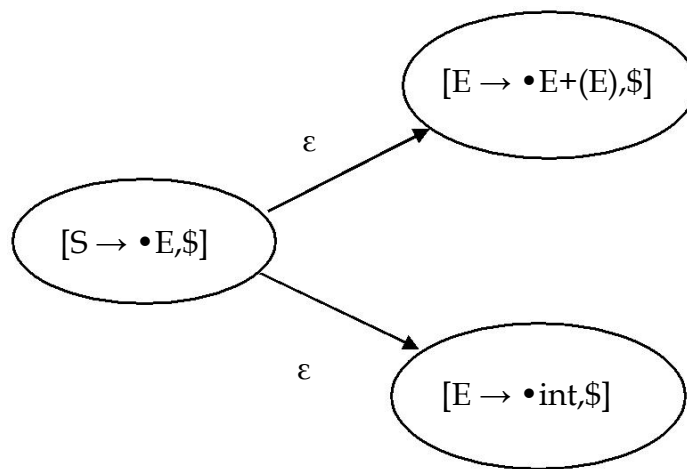

Algorithm:

Construction of collection of canonical sets of LR(1) items.

Input:

An augmented grammar G'

Output:

Collection of canonical (CC) sets of LR(1)

$\underline{CC}(G')$

$I_0 \leftarrow \{\text{closure}([S' \rightarrow \bullet S, \$])\}$

$CC \leftarrow \{ I_0 \}$

repeat

for each unmarked set $I_j \in CC$

mark I_j *as processed*

for each X *following* \bullet *in an item in* I_j

$I_k \leftarrow$

 goto(I_j, X) *if* I_k

$\notin CC$ *then*

$CC \leftarrow CC \cup I_k$

record transition from I_j *to* I_k *on*

X until CC is not changing

We use the algorithm to compute the sets of LR(1) items for the augmented grammar G'

$$\begin{aligned} S &\rightarrow E \\ E &\rightarrow E + (E) \mid \underline{\text{int}} \end{aligned}$$

We computed I_0 ; we now compute the sets $\text{goto}(I_0, X)$ for various values of X . X can be $E, \text{int}, +, ($ and $)$.

$I_1 = \text{goto}(I_0, \text{int})$: invokes $\text{closure}(\{[E \rightarrow \text{int}\bullet, \$/+]\})$. No additional closure is possible since the dot is at the right end of the production. Thus $I_1 = \{[E \rightarrow \text{int}\bullet, \$/+]\}$ and we have the transition from I_0 to I_1 on int

$I_2 = \text{goto}(I_0, E)$

$$\begin{aligned} m &\leftarrow \{\} \\ \text{for each } [X \rightarrow \bullet E, b] &\in I_0 \\ &\quad \square [S \rightarrow \bullet E, \$] \\ &\quad \square [E \rightarrow \bullet E+(E), \$/+] \\ \\ m &= m \cup \{[S \rightarrow E\bullet, \$]\} \cup \{[E \rightarrow E\bullet+(E), \$/+]\} \\ &\text{return } \text{closure}(m) \end{aligned}$$

No further closure for the first item because \bullet is at the end

In the second item, a terminal $+$ appears after \bullet so no further closure is possible. Thus $I_2 = \{[S \rightarrow E\bullet, \$], [E \rightarrow E\bullet+(E), \$/+]\}$.

We repeat the process in similar fashion.

$I_3 = \text{goto}(I_2, +) = \{[E \rightarrow E + \bullet (E), \$/+]\}$

$I_4 = \text{goto}(I_3, ()) = \{ [E \rightarrow E + (\bullet E), \$/+], [E \rightarrow \bullet E + (E),)/+], [E \rightarrow \bullet \underline{\text{int}},)/+]\}$

$I_3 = \text{goto}(I_2, +) = \{ [E \rightarrow E + \bullet (E), \$/+]\}$

$I_4 = \text{goto}(I_3, ()) = \{ [E \rightarrow E + (\bullet E), \$/+], [E \rightarrow \bullet E + (E),)/+], [E \rightarrow \bullet \underline{\text{int}},)/+]\}$

$I_5 = \text{goto}(I_4, \text{int}) = \{ [E \rightarrow \text{int} \bullet,)/+]\}$

$I_6 = \text{goto}(I_4, E) = \{ [E \rightarrow E + (E \bullet), \$/+], [E \rightarrow E \bullet + (E),)/+]\}$

and so on. The sets and transitions so far yield the DFA

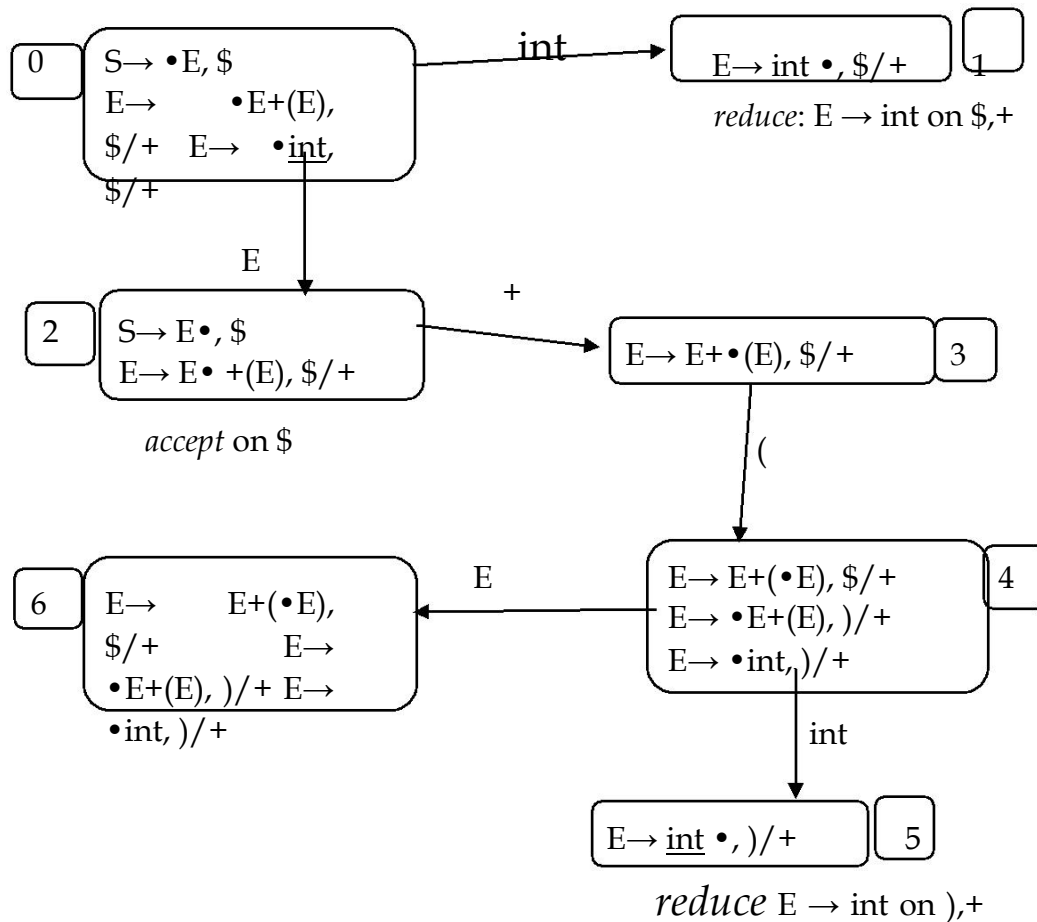

Lecture 27

LR Table Construction

Construct $CC = \{I_0, I_1, I_2, \dots, I_n\}$, for G' . State i of the parser is constructed from the set I_i . The parsing actions for state i are determined as follows:

```
for each item  $I_i \in CC$ 
  if  $[A \rightarrow \alpha \bullet a \beta, b] \in I_i$  and  $\text{goto}(I_i, a) = I_j$ 
    then  $\text{Action}[i, a] \leftarrow \text{"shift } j\text{"}$ 
  else if  $[A \rightarrow \bullet, a] \in I_i$  and  $A \neq S'$  then
     $\text{Action}[i, a] \leftarrow \text{"reduce } A \rightarrow \alpha\text{"}$ 
  " else if  $[S' \rightarrow S \bullet, \$] \in I_i$  then
     $\text{Action}[i, a] \leftarrow \text{"accept"}$ 
end for

// the goto table
for each non-terminal  $A \in G$ 
  if  $\text{goto}(I_i, A) = I_j$  then
     $\text{Goto}[i, A] \leftarrow j$ 
```

The initial state is the one that contains the item $[S' \rightarrow \bullet S, \$]$. All remaining entries are marked "error". Let us go through an example and construct the LR table for the augmented grammar

1. $S' \rightarrow E$
2. $E \rightarrow T - E$
3. $E \rightarrow T$
4. $T \rightarrow F \times T$
5. $T \rightarrow F$
6. $F \rightarrow \text{id}$

The FIRST sets we would need are

Symbol	FIRST
S'	{ id }
E	{ id }
T	{ id }
F	{ id }
id	{ id }
\times	{ \times }
$-$	{ $-$ }

We construct the canonical collection of set of LR(1)

$$I_0 = \{\text{closure}([S' \rightarrow \bullet E, \$])\}$$

$$\{$$

$$\begin{aligned} & [S' \rightarrow \bullet E, \$], \\ & [E \rightarrow \bullet T - E, \$], [E \rightarrow \bullet T, \$], \\ & [T \rightarrow \bullet F \times T, \$], [T \rightarrow \bullet F, \$] \\ & [T \rightarrow \bullet F \times T, -], [T \rightarrow \bullet F, -], \\ & [F \rightarrow \bullet \text{id}, \$], [F \rightarrow \bullet \text{id}, -], \\ & [F \rightarrow \bullet \text{id}, \times] \end{aligned}$$

$$\}$$

$$I_1 = \{\text{goto}(I_0, E)\} = \{[S' \rightarrow E \bullet, \$]\}$$

$$I_2 = \{\text{goto}(I_0, T)\} = \{[E \rightarrow T \bullet - E, \$], [E \rightarrow T \bullet, \$]\}$$

$$I_3 = \{\text{goto}(I_0, F)\} = \{$$

$$\begin{aligned} & [T \rightarrow F \bullet \times T, \$], \\ & [T \rightarrow F \bullet, \$], \\ & [T \rightarrow F \bullet \times T, -], \\ & [T \rightarrow F \bullet, -] \end{aligned}$$

$$\}$$

$$I_4 = \{\text{goto}(I_0, \text{id})\} = \{$$

$$\begin{aligned} & [F \rightarrow \text{id} \bullet, \$], \\ & [F \rightarrow \text{id} \bullet, -], \\ & [F \rightarrow \text{id} \bullet, \times] \end{aligned}$$

$$\}$$

$$I_5 = \{\text{goto}(I_2, -)\} = \{$$

$$\begin{aligned} & [E \rightarrow T - \bullet E, \$], [E \rightarrow \bullet T - E, \$], [E \rightarrow \bullet T, \$], \\ & [T \rightarrow \bullet F \times T, \$], [T \rightarrow \bullet F \times T, -], [T \rightarrow \bullet F, \$], [T \rightarrow \bullet F, -], \\ & [F \rightarrow \bullet \text{id}, \$], [F \rightarrow \bullet \text{id}, -], [F \rightarrow \bullet \text{id}, \times] \end{aligned}$$

$$\}$$

$$I_6 = \{\text{goto}(I_3, \times)\} = \{$$

$$\begin{aligned} & [T \rightarrow F \times \bullet T, \$], [T \rightarrow F \times \bullet T, -], \\ & [T \rightarrow \bullet F \times T, \$], [T \rightarrow \bullet F \times T, -], [T \rightarrow \bullet F, \$], [T \rightarrow \bullet F, -], \\ & [F \rightarrow \bullet \text{id}, \$], [F \rightarrow \bullet \text{id}, -], [F \rightarrow \bullet \text{id}, \times] \end{aligned}$$

$$\}$$

$$I_7 = \{\text{goto}(I_5, E)\} = \{[E \rightarrow T - E \bullet, \$]\}$$

$I_2 = \{\text{goto}(I_5, T)\}$, i.e., $\text{goto}(I_5, T)$ yields the same set as I_2 .

$$I_3 = \{\text{goto}(I_5, F)\}$$

$$I_4 = \{\text{goto}(I_5, \text{id})\}$$

$$I_8 = \{\text{goto}(I_6, T)\} = \{ [T \rightarrow F \times T \bullet, \$], [T \rightarrow F \times T \bullet, -] \}$$

$$I_3 = \{\text{goto}(I_6, F)\}$$

$$I_4 = \{\text{goto}(I_6, \text{id})\}$$

We now filling the LR(1) table by applying the rules.

Apply

1. if $[A \rightarrow \alpha \bullet a \beta, b] \in I_i$ and $\text{goto}(I_i, a) = I_j$
then set $\text{Action}[i, a] \leftarrow$ "shift j". // here, a is a terminal.

$$I_0 = \{ [S' \rightarrow \bullet E, \$], [E \rightarrow \bullet T - E, \$], \\ [E \rightarrow \bullet T, \$], [T \rightarrow \bullet F \times T, \$], \\ [T \rightarrow \bullet F \times T, -], [T \rightarrow \bullet F, \$], \\ [T \rightarrow \bullet F, -], [F \rightarrow \bullet \text{id}, \$], [F \\ \rightarrow \bullet \text{id}, -], [F \rightarrow \bullet \text{id}, \times] \}$$

$$\text{goto}(I_0, \text{id}) = I_4 \\ \rightarrow \text{Action}[0, \text{id}] \leftarrow \text{shift 4}$$

$$I_2 = \{ [E \rightarrow T \bullet - E, \$], [E \rightarrow T \bullet, \$] \}, \text{goto}(I_2, -) = I_5 \\ \rightarrow \text{Action}[2, -] \leftarrow \text{shift 5}$$

$$I_3 = \{ [T \rightarrow F \bullet \times T, \$], [T \rightarrow F \bullet, \$], [T \rightarrow F \bullet \times T, -], [T \rightarrow F \bullet, -] \}, \text{goto}(I_3, \times) = I_6 \\ \rightarrow \text{Action}[3, \times] \leftarrow \text{shift 6}$$

$$\text{goto}(I_5, \text{id}) = I_4 \\ \rightarrow \text{Action}[5, \text{id}] \leftarrow \text{shift 4}$$

$$\text{goto}(I_6, \text{id}) = I_4 \\ \rightarrow \text{Action}[6, \text{id}] \leftarrow \text{shift 4}$$

Apply

2. if $[A \rightarrow \alpha \bullet, a] \in I_i$ and $A \neq S'$ then set $\text{action}[i, a]$ to "reduce $A \rightarrow \alpha$ "

$$I_2 = \{ [E \rightarrow T \bullet - E, \$], [E \rightarrow T \bullet, \$] \} \\ \rightarrow \text{Action}[2, \$] \leftarrow \text{reduce 3}$$

$$I_3 = \{ [T \rightarrow F \bullet \times T, \$], [T \rightarrow F \bullet, \$], [T \rightarrow F \bullet \times T, -], [T \rightarrow F \bullet, -] \} \\ \rightarrow \text{Action}[3, \$] \leftarrow \text{reduce 5} \\ \rightarrow \text{Action}[3, -] \leftarrow \text{reduce 5}$$

$I_4 = \{ [F \rightarrow id \bullet, \$], [F \rightarrow id \bullet, -], [F \rightarrow id \bullet, \times] \}$
 $\rightarrow \text{Action}[4, \$] \leftarrow \text{reduce } 6$
 $\rightarrow \text{Action}[4, -] \leftarrow \text{reduce } 6$
 $\rightarrow \text{Action}[4, \times] \leftarrow \text{reduce } 6$

$I_7 = \{ [E \rightarrow T - E \bullet, \$] \}$
 $\rightarrow \text{Action}[7, \$] \leftarrow \text{reduce } 2$

$I_8 = \{ [T \rightarrow F \times T \bullet, \$], [T \rightarrow F \times T \bullet, -] \}$
 $\rightarrow \text{Action}[8, \$] \leftarrow \text{reduce } 4$
 $\rightarrow \text{Action}[8, -] \leftarrow \text{reduce } 4$

Apply

3. if $[S' \rightarrow S \bullet, \$] \in I_i$
 then set action[i,\$] to "accept"

$I_1 = \{ [S' \rightarrow E \bullet, \$] \}$
 $\rightarrow \text{Action}[1, \$] \leftarrow \text{accept}$

Apply

for each non-terminal $A \in G$
 if $\text{goto}(I_i, A) = I_j$ then $\text{goto}[i, A] \leftarrow j$.

$\text{goto}(I_0, E) = I_1 \rightarrow \text{goto}[0, E] \leftarrow 1$
 $\text{goto}(I_0, T) = I_2 \rightarrow \text{goto}[0, T] \leftarrow 2$
 $\text{goto}(I_0, F) = I_3 \rightarrow \text{goto}[0, F] \leftarrow 3$
 $\text{goto}(I_5, E) = I_7 \rightarrow \text{goto}[5, E] \leftarrow 7$
 $\text{goto}(I_5, T) = I_2 \rightarrow \text{goto}[5, T] \leftarrow 2$
 $\text{goto}(I_5, F) = I_3 \rightarrow \text{goto}[5, F] \leftarrow 3$
 $\text{goto}(I_6, T) = I_8 \rightarrow \text{goto}[6, T] \leftarrow 8$
 $\text{goto}(I_6, F) = I_3 \rightarrow \text{goto}[6, F] \leftarrow 3$

The final table we get is

	Action				Goto		
	id	-	×	\$	E	T	F
0	s4				1	2	3
1				<i>acc</i>			
2		s5		r3			
3		r5	s6	r5			
4		r6	r6	r6			
5	s4				7	2	3
6	s4					8	3
7				r2			
8		r4		r4			

Let us parse the expression $x - y \times z$ using the LR(1) table. The scanner will encode the input string as $id - id \times id \$$ where $\$$ is the EOF marker

Stack	Input	
ϵ	$id - id \times id \$$	s4
ϵid	$- id \times id \$$	r6 F \rightarrow id
ϵF	$- id \times id \$$	r5 T \rightarrow F
ϵT	$- id \times id \$$	s5
$\epsilon T - 5$	$id \times id \$$	s4
$\epsilon T - 5 id$	$\times id \$$	r6 F \rightarrow id
$\epsilon T - 5 F$	$\times id \$$	s6
$\epsilon T - 5 F \times 6$	$id \$$	s4
$\epsilon T - 5 F \times 6 id$	$\$$	r6 F \rightarrow id
$\epsilon T - 5 F \times 6 F$	$\$$	r5 T \rightarrow F
$\epsilon T - 5 F \times 6 T$	$\$$	r4 T \rightarrow F \times T
$\epsilon T - 5 T$	$\$$	r3 E \rightarrow T
$\epsilon T - 5 E$	$\$$	r2 E \rightarrow T - E
ϵE	$\$$	<i>accept</i>

Lecture 28

LR(1) Skeleton Parser

```
stack.push(dummy);
stack.push(0); done = false;
token = scanner.next(); while
(!done) {
    s = stack.top();
    if( Action[s,token] == "reduce
        A→β" ) { stack.pop(2× |β| );
        s = stack.top();
        stack.push(A);
        stack.push(Goto[s,A]
            );
    }
    else if( Action[s,token] == "shift i"){
        stack.push(token);
        stack.push(i);
        token = scanner.next();
    }
    else if(Action[s,token] ==
        "accept" && token ==
        "$" )
        done = true;
    else
        report error and recover;
}
report success;
```

Shift/Reduce Conflicts

If a DFA states contains both $[X \rightarrow \alpha \bullet a \beta, b]$ and $[Y \rightarrow \gamma \bullet, a]$ Then on input "a" we could either shift into state $[X \rightarrow \alpha a \bullet \beta, b]$, or reduce with $Y \rightarrow \gamma$. This is called a *shift-reduce conflict*. Typically, this is due to ambiguities in the grammar. The classic example of a shift-reduce conflict is the dangling else. Consider the grammar

$$\text{stmt} \rightarrow \underline{\text{if}} \ E \ \underline{\text{then}} \ \text{stmt} \\ \quad \quad | \quad \underline{\text{if}} \ E \ \underline{\text{then}} \ \text{stmt} \ \underline{\text{else}} \ \text{stmt}$$

We will have DFA state containing

[stmt → if E then stmt •, else]
[stmt → if E then stmt • else stmt, x]

If else follows, we can shift

[stmt → if E then stmt else • stmt, x]

or reduce

[stmt → if E then stmt •, else]

Typical action is shift so that else matches with most recent if.

Lecture 29

Shift/Reduce Conflicts

Consider the ambiguous grammar

$$E \rightarrow E + E \mid E \times E \mid \text{int}$$

We will DFA state containing

$$\begin{aligned} & [E \rightarrow E \times E \bullet, +] \\ & [E \rightarrow E \bullet + E, +] \end{aligned}$$

Again we have a shift/reduce conflict. We need to reduce because \times has precedence over $+$

Reduce/Reduce Conflicts

If a DFA state contains both $[X \rightarrow \alpha \bullet, a]$ and $[Y \rightarrow \beta \bullet, a]$, then on input "a" we don't know which production to reduce with. This is called a *reduce-reduce conflict*. Usually due to gross ambiguity in the grammar.

LR(1) Table Size

LR(1) parsing table for even a simple language can be extremely large with thousands of entries. It is possible to reduce the size of the table. Many states in the DFA are similar.

The *core* of set of LR items is the set of first components without the lookahead terminals. For example the core of the item $\{ [X \rightarrow \alpha \bullet \beta, b], [Y \rightarrow \gamma \bullet \delta, d] \}$ is $\{ X \rightarrow \alpha \bullet \beta, Y \rightarrow \gamma \bullet \delta \}$. Consider the LR(1) states

$$\begin{aligned} & \{ [X \rightarrow \alpha \bullet, a], [Y \rightarrow \beta \bullet, c] \} \\ & \{ [X \rightarrow \alpha \bullet, b], [Y \rightarrow \beta \bullet, d] \} \\ & \} \end{aligned}$$

They have the same core and can be merged. The merged state contains

$$\{ [X \rightarrow \alpha \bullet, a/b], [Y \rightarrow \beta \bullet, c/d] \}$$

These are called the *LALR(1) states*. LALR(1) stands for LookAhead LR(1). This leads to tables that have 10 times fewer states than LR(1).

Here is the algorithm to generate LALR(1) DFA.

1. Repeat until all states have distinct code
2. choose two distinct states with same core
3. merge states by creating a new one with the union of all the items point edges from predecessors to new state
4. new state points to all the previous successors

LALR languages are not natural. They are an efficiency hack on LR languages. Any reasonable programming language has a LALR(1) grammar. LALR(1) has become a standard for programming languages and for parser generators.

Lecture 30

Parser Generators

Parser generators exist for LL(1) and LALR(1) grammars. For example,

- LALR(1) - YACC, Bison, CUP
- LL(1) - ANTLR
- Recursive Descent - JavaCC

YACC Parser Generator

YACC - Yet Another Compiler Compiler, appeared in 1975 as a Unix application. The other companion application Lex appeared at the same time. These two greatly aided the construction of compilers and interpreters. The input to YACC consists of a specification text file. The structure of the file is

definitions

%%

rules

%%

C/C++ functions

Here, for example, is the YACC file for a calculator

```
%token NUMBER LPAREN RPAREN
```

```
%token PLUS MINUS TIMES DIVIDE
```

```
%%
```

```
  expr : expr PLUS expr
        | expr MINUS expr
        | expr TIMES expr
        | expr DIVIDE expr
        | LPAREN expr RPAREN
        | MINUS expr
        | NUMBER
        ;
```

```
%%
```

The Flex input file for a calculator is

```
%{
#include "y.tab.h"
%}
digit          [0-9]
ws             [ \t\n]+
%%
{ws}          ;
{digit}+     {return NUMBER;}
"+"          {return PLUS;}
"*"          {return TIMES;}
"/"          {return DIVIDE;}
"_"          {return MINUS;}
%%
```

The following diagram outlines the process of building a parser with YACC and Lex.

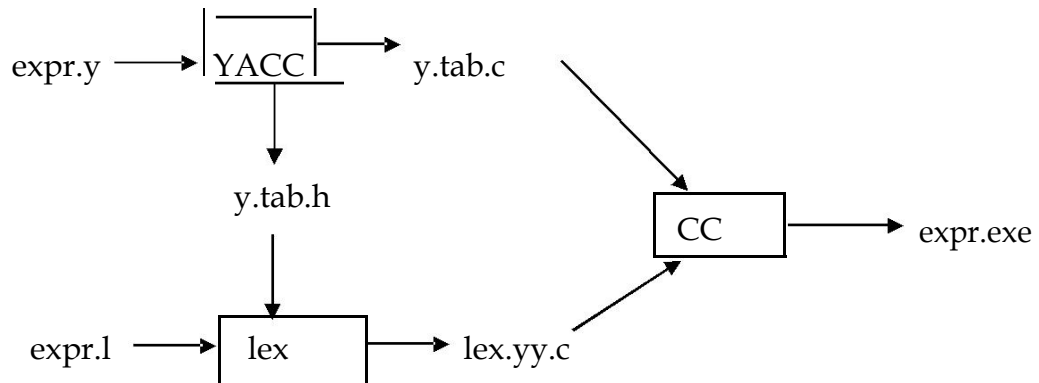

Lecture 31

Beyond Syntax

These questions are part of context-sensitive analysis. Answers depend on values, not parts of speech. Answers may involve computation.

These questions can be answered by using formal methods such as context-sensitive grammars and attribute grammars or by using ad-hoc techniques.

One of the most popular is the use of attribute grammars.

Attribute Grammars

A CFG is augmented with a *set of rules*. Each symbol in the derivation has a set of values or *attributes*. Rules specify how to *compute* a value for each attribute

Consider the grammar for *signed binary numbers (SBN)*

```
Number    → Sign List
Sign      → + -
List      → List Bit | Bit
Bit       → 0 1
```

The string “-1” can be derived as follows:

```
Number    → Sign List
           → - List
           → - Bit
           → - 1
```

Similarly, the derivation for “-101” is

```
Number    → Sign List
           → Sign List Bit
           → Sign List 1
           → Sign List Bit 1
           → Sign List 0 1
           → Sign Bit 0 1
           → Sign 1 0 1
           → - 1 0 1
```

For an *attributed version* of SBN, the following attributes are needed

<i>Symbol</i>	<i>Attributes</i>
Number	val
Sign	neg
List	pos, val
Bit	pos, val

We will add rules to compute decimal value of a signed binary number

<i>Productions</i>	<i>Attribution Rules</i>
Number \rightarrow Sign List	List.pos \leftarrow 0 if Sign.neg then Number.val \leftarrow - List.val else Number.val \leftarrow List.val
Sign \rightarrow +	Sign.neg \leftarrow false
Sign \rightarrow -	Sign.neg \leftarrow true
List0 \rightarrow List1 Bit	List1.pos \leftarrow List0.pos + 1 Bit.pos \leftarrow List0.pos List0.val \leftarrow List1.val + Bit.val
List \rightarrow Bit	Bit.pos \leftarrow List.pos List.val \leftarrow Bit.val
Bit \rightarrow 0	Bit.val \leftarrow 0
Bit \rightarrow 1	Bit.val \leftarrow $2^{\text{Bit.pos}}$

Attributes are associated with nodes in parse tree. Rules are value assignments associated with productions. Rules and parse tree define an attribute dependence graph which must be acyclic.

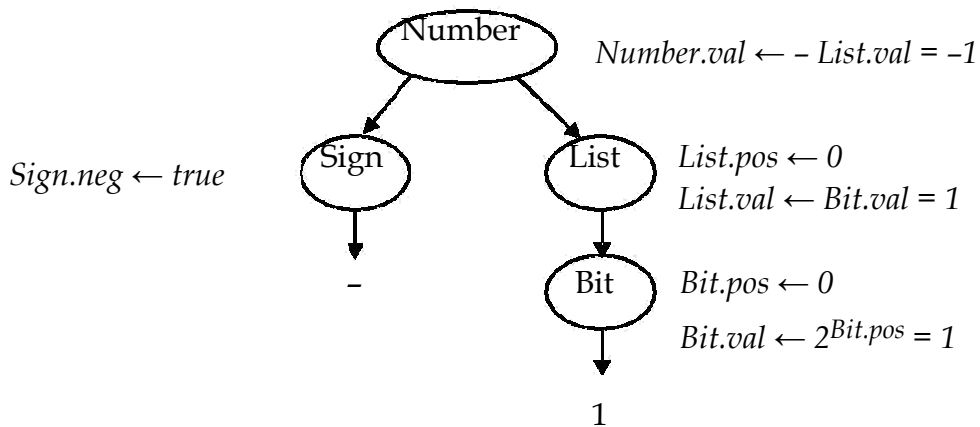

Attributes are distinguished based on the direction of value flow. Attributes of a node whose values are defined wholly in terms of attributes of node's children and from constants are called *synthesized attributes*. Values used to compute synthesized attributes flow bottom-up in the parse tree.

Attributes whose values are defined in terms of a node's own attributes, node's siblings and node's parent are called *inherited attributes*. Values flow top-down and laterally in the parse tree. The following attributed tree shows the inherited and synthesized attributes for the input signed binary number -101.

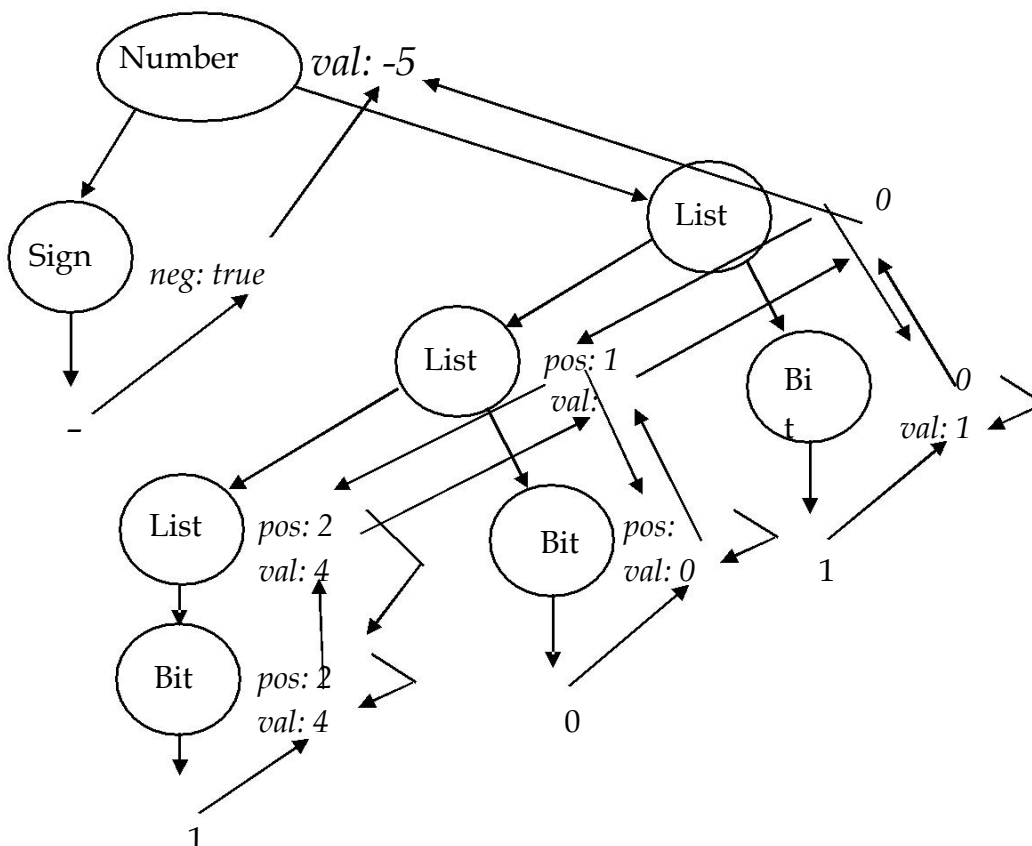

When the parse tree is peeled away, we get the attribute dependence graph

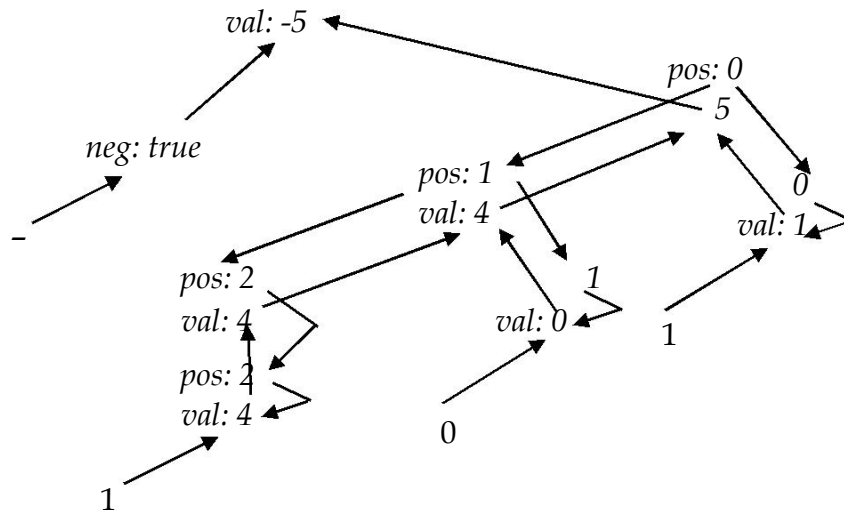

Lecture 32

Evaluation Methods

A number of ways can be used to evaluate the attributes. When using *Dynamic method*, the compiler application builds the parse tree and then builds the dependence graph. A topological sort of the graph is carried out and attributes are evaluated or defined in topological order. In *rule-based (or treewalk)* methodology, the attribute rules are analyzed at compiler-generation time. A fixed (static) ordering is determined and the nodes in the dependency graph are evaluated this order. In *oblivious (passes, dataflow)* methodology, the attribute rules and parse tree are ignored. A convenient order is picked at compiler design time and used.

Attribute grammars have not achieved widespread use due to a number of problems. For example: non-local computation, traversing parse tree, storage management for short-lived attributes and lack of high-quality inexpensive tools. However, a variation of attribute grammars and evaluation schemes is used in many compilers. This variation is called *ad-hoc analysis*.

In rule-based evaluators, a sequence of actions is associated with grammar productions. Organizing actions required for context-sensitive analysis around structure of the grammar leads to powerful, albeit ad-hoc, approach which is used on most parsers. A snippet of code (*action*) is associated with each production that executes at parse time. In top-down parsers, the snippet is added to the appropriate parsing routine. In a bottom-up shift-reduce parsers, the actions are performed each time the parser performs a reduction. Here the LR(1) skeleton parser indicating the place where the snippet is executed.

```
stack.push(dummy);
stack.push(0); done = false; token
= scanner.next(); while (!done) {
    s = stack.top();
    if( Action[s,token] == "reduce A→β")
        { invoke the code snippet
          stack.pop(2× |β|);
          s = stack.top();
          stack.push(A);
          stack.push(Goto[s,A]);
        }
    else if( Action[s,token] == "shift i"){
```

```

        stack.push(token);
        stack.push(i); token =
        scanner.next();
    }
}

```

The following table shows the code snippets for the SBN example.

<i>Productions</i>	<i>Code snippet</i>
Number \rightarrow Sign List	Number.val \leftarrow - Sign.val \times List.val
Sign \rightarrow +	Sign.val \leftarrow 1
Sign \rightarrow -	Sign.val \leftarrow -1
List \rightarrow Bit	List.val \leftarrow Bit.val
List ₀ \rightarrow List ₁ Bit	List ₀ .val \leftarrow 2 \times List ₁ .val + Bit.val
Bit \rightarrow 0	Bit.val \leftarrow 0
Bit \rightarrow 1	Bit.val \leftarrow 1

Lecture 33

Implementing Ad-Hoc Scheme

The parser needs a mechanism to pass values of attributes from definitions in one snippet to uses in another. We will adopt notation used by YACC for snippets and passing values. Recall that the skeleton LR(1) parser stored two values on the stack $\langle symbol, state \rangle$. We can replace this with triples $\langle value, symbol, state \rangle$. On a reduction by $A \rightarrow \beta$, the parser pops $3 \times |\beta|$ items from the stack rather than $2 \times |\beta|$. It pushes value along with the symbol.

Lecture 34

Let's go through an example of using YACC to implement the ad-hoc scheme for an arithmetic calculator.

The YACC file for a calculator grammar is as follows:

```
%token NUMBER LPAREN RPAREN
%token PLUS MINUS TIMES DIVIDE
%%
    expr : expr PLUS expr
          | expr MINUS expr
          | expr TIMES expr
          | expr DIVIDE expr
          | LPAREN expr RPAREN
          | MINUS expr
          | NUMBER
    ;
%%
```

We will add the code snippets

```
{
#include <iostream>
}
// type of value entries in the parse stack
%union      {int val;}

%token NUMBER LPAREN RPAREN EQUAL
%token PLUS MINUS TIMES DIVIDE
/* associativity and precedence:in order of increasing
   precedence */
%nonassoc   EQUAL
%left PLUS MINUS
%left TIMES  DIVIDE
%left UMINUS /* dummy token to use as
              precedence marker */
%type <val>  NUMBER expr
%%

prog : expr      { cout << $1 << endl;}
Sohail Aslam                                     Compiler Construction CS606
```

```

;
expr : expr PLUS expr          {$$ = $1 + $3;}
| expr MINUS expr {$$ = $1 - $3;}
| expr TIMES expr {$$ = $1 * $3;}
| expr DIVIDE expr {if($3) $$ = $1 / $3;}
| LPAREN expr RPAREN {$$ = $2;}
| MINUS expr          {$$ = -$2;}
| NUMBER             {$$ = $1;}
;

```

The '\$' notation is used by YACC to refer to values of symbols on the right hand side of the grammar production. For example, for **expr : expr PLUS expr**, **\$1** refers to first **expr** on the right, **\$2** refers to **PLUS** and **\$3** refers to the second non-terminal **expr**. The notation **\$\$** refers to the symbol on the left hand side of the production. Internally, the **\$1** refers to the attribute value associated with the first grammar symbol, **\$2** with the second, **\$3** with the third and so on. These values are stored in the parse stack. The notation **\$\$** instructs YACC to push a computed attribute value on the stack and associate it with the symbol on the left when the reduction takes place.

The following attributed tree shows the values as they are computed in a bottom-up parse

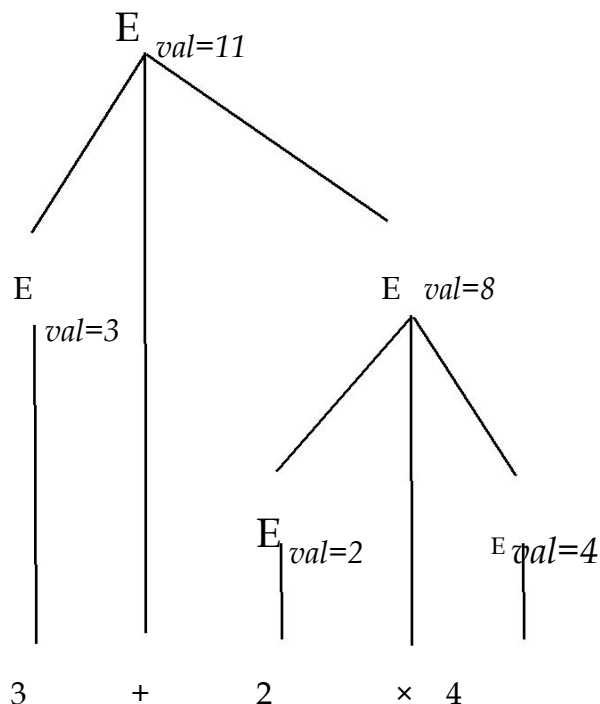

(note: please see the file “lex_yacc.pdf” for additional information on using YACC.)

Intermediate Representations

Compilers are organized as a series of passes. This creates the need for an *intermediate representation* (IR) for the code being compiled. Compilers use some internal form— an IR —to represent the code being analyzed and translated. Many compilers use more than one IR during the course of compilation.

The IR must be expressive enough to record all of the useful facts that might be passed between passes of the compiler. During translation, the compiler derives facts that have no representation in the source code. For example, the addresses of variables and procedures are not specified in the code being compiled. Typically, the compiler augments the IR with a set of tables that record additional information. Foremost among these is the *symbol table*. These tables are considered part of the IR

Selecting an appropriate IR for a compiler project requires an understanding of both the source language and the target machines and the properties of the programs to be compiled. Thus, a source-to-source translator e.g., C++ to Java, might keep its internal information in a form quite close to the source. In contrast, a compiler that produces assembly code might use a form close to the target machine’s instruction set.

Lecture 35

IR Taxonomy

IRs fall into three organizational categories:

1. *Graphical* IRs encode the compiler's knowledge in a graph.
2. *Linear* IRs resemble pseudo-code for some abstract machine
3. *Hybrid* IRs combine elements of both graphical (structural) and linear IRs

Graphical IRs

Parse trees are graphs that represent source-code form of the program. The structure of the tree corresponds to the syntax of the source code. Parse trees are used primarily in discussion of parsing and in attribute grammar systems where they are the primary IR. In most other applications, compilers use one of the more concise alternatives. An *abstract syntax tree* (AST) retains the essential structure of the parse tree but eliminates extraneous nodes. Here, for example,

is the AST for the expression $a = b * -c + b * -c$. Notice how all derivation related information has been removed.

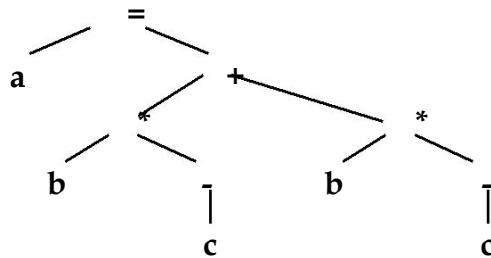

ASTs have been used in many practical compiler systems such as source-to-source systems, automatic parallelization tools, pretty-printing etc.

AST is more concise than a parse tree. It faithfully retains the structure of the original source code. Consider the AST for $x^2 + x^2 * y$

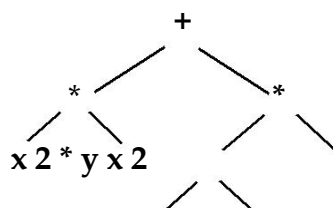

The AST contains two distinct copies of $x*2$. A *directed acyclic graph* (DAG) is a contraction of the AST that avoids duplication.

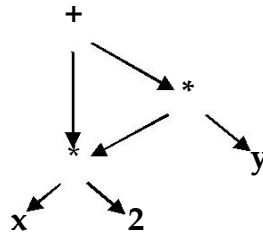

If the value of x does not change between uses of $x*2$, the compiler can generate code that evaluates the subtree once and uses the result twice.

The task of building AST fits neatly into an ad hoc-syntax-directed translation scheme. Assume that the compiler has routines `mknnode` and `mkleaf` for creating tree nodes. The following rules can be attached to the expression grammar to create AST.

<i>Production</i>	<i>Semantic Rule</i>
$E \rightarrow E1 + E2$	$E.nptr = \text{mknnode}('+', E1.nptr, E2.nptr)$
$E \rightarrow E1 * E2$	$E.nptr = \text{mknnode}('*', E1.nptr, E2.nptr)$
$E \rightarrow - E1$	$E.nptr = \text{mknnode}('-', E1.nptr)$
$E \rightarrow (E1)$	$E.nptr = E1.nptr$
$E \rightarrow \text{num}$	$E.nptr = \text{mkleaf}('num', \text{num.val})$

The following table shows the same rules using YACC syntax.

<i>Production</i>	<i>Semantic Rule (yacc)</i>
$E \rightarrow E1 + E2$	$$$nptr = \text{mknnode}('+', \$1.nptr, \$3.nptr)$
$E \rightarrow E1 * E2$	$$$nptr = \text{mknnode}('*', \$1.nptr, \$3.nptr)$
$E \rightarrow - E1$	$$$nptr = \text{mknnode}('-', \$1.nptr)$
$E \rightarrow (E1)$	$$$nptr = \$1.nptr$
$E \rightarrow \text{num}$	$$$nptr = \text{mkleaf}('num', \$1.val)$

We will use another IR, called *three-address code*, for actual code generation. The semantic rules for generating three-address code for common programming languages constructs are similar to those for AST.

Linear IRs

The alternative to graphical IR is a linear IR. An assembly-language program is a form of linear code. It consists of a sequence of instructions that execute in order of appearance. Two linear IRs used in modern compilers are *stack-machine code* and *three-address code*.

Stack-machine code is sometimes called one-address code. It assumes the presence of an operand stack. Most operations take their operands from the stack and push results back onto the stack. Here, for example, is the linear IR for $x - 2 \times y$

<i>stack-machine</i>	<i>three-address</i>
push 2	t1 ← 2
push y	t2 ← y
multiply	t3 ← t1 × t2
push x	t4 ← x
subtract	t5 ← t4 - t3

Stack-machine code is compact; it eliminates many names from IR. This shrinks the program in IR form. All results and arguments are transitory unless explicitly moved to memory. Stack-machine code is simple to generate and execute. Smalltalk-80 and Java use byte-codes which are abstract stack-machine code. The byte-code is either interpreted or translated into target machine code (JIT).

In *three-address code* most operations have the form

$$x \leftarrow y \text{ op } z$$

with an operator (**op**), two operands (**y and z**) and one result (**x**). Some operators, such as an immediate load and a jump, will need fewer arguments.

Lecture 36

Three-address code is attractive for several reasons. Absence of destructive operators gives the compiler freedom to reuse names and values. Three-address code is reasonably compact: operations are 1 to 2 bytes; addresses are 4 bytes. Many modern processors implement three-address operations; a three-address code models their properties well

We now consider *syntax-directed translation* schemes using three-address code for various programming constructs. We start with the *assignment statement*.

Assignment Statement

<i>Production</i>	<i>translation scheme</i>
$S \rightarrow id = E$	{ p = lookup(id.name); emit(p, '=', E.place); }
$E \rightarrow E1 + E2$	{ E.place = newtemp(); emit(E.place, '=', E1.place, '+', E2.place); }
$E \rightarrow E1 * E2$	{ E.place = newtemp(); emit(E.place, '=', E1.place, '*', E2.place); }
$E \rightarrow - E1$	{ E.place = newtemp(); emit(E.place, '=', '-', E1.place); }
$E \rightarrow (E1)$	{ E.place = E1.place; }
$E \rightarrow id$	{ p = lookup(id.name); emit(E.place, '=', p); }

The translation scheme uses a *symbol table* for identifiers and temporaries. Every time the parser encounters an identifier, it installs it in the symbol table. The symbol table can be implemented as a hash table or using some other efficient data structure for table. The routine **lookup(name)** checks if there an entry for the name in the symbol table. If the **name** is found, the routine returns a pointer to entry. The routine **newtemp()** returns a new temporary in response to successive calls. Temporaries can be placed in the symbol table. The routine **emit()** generates a three-address statement which can either be held in memory or written to a file. The attribute E.place records the symbol table location.

Lecture 37

Here is the bottom-up parse of the assignment statement $a = b * -c + b * -c$ and the syntax-directed translation into three-address code.

<i>Parser action</i>	<i>attribute</i>	<i>Three- address code</i>
id=id * -id + id * -id		
id=E1 * -id + id * -id	E1.place = b	
id=E1 * -E2 + id * -id	E2.place = c	
id=E1 * E2 + id * -id	E2.place = t1	t1 = - c
id=E1 + id * -id	E1.place = t2	t2 = b*t1
id=E1 + E2 * -id	E2.place = b	
id=E1 + E2 * -E3	E3.place = c	
id=E1 + E2 * E3	E3.place = t3	t3 = - c
id=E1 + E2	E2.place = t4	t4 = b*t3
id=E1	E1.place = t5	t5 = t2+t4
S		a = t5

Representing Linear Codes

Three-address codes are often implemented as a *set of quadruples*. Each quadruple has four fields: an operator, two operands (or sources) and a destination. In C++, for example, one can design a quadruple class and then declare a simple array of quadruples. This leads to the following arrangement; the index of the array element acts as the number of quadruple generated.

<i>Target</i>	<i>Op</i>	<i>Arg1</i>	<i>Arg2</i>
t1	←	2	
t2	←	y	
t3	×	t1	t2
t4	←	x	
t5	-	t4	t3

An array of pointers to quads can be employed which leads to the following structure:

‡

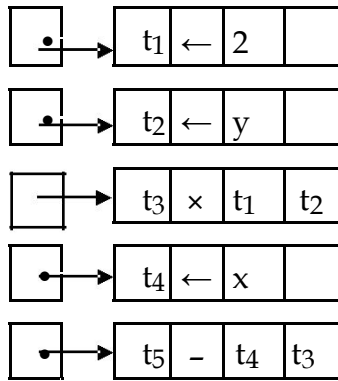

Both simple array and array of pointers have maximum size limitation. This limitation can be overcome by using a linked list of quads:

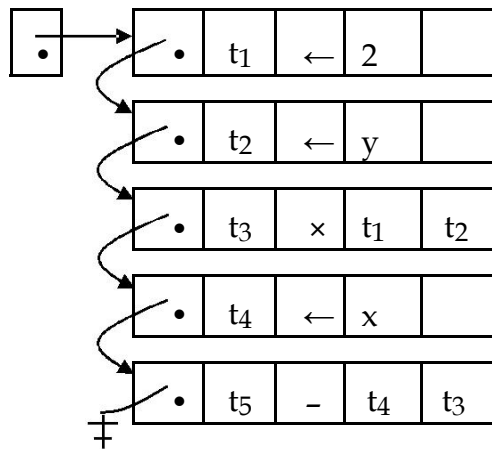

Flow-of-Control Statements

We now use the syntax-directed translation scheme for the flow-of-control statements found in most procedural programming languages.

$$\begin{array}{l}
 S \rightarrow \text{if } E \text{ then } S_1 \\
 \quad | \quad \text{if } E \text{ then } S_1 \text{ else } S_2 \\
 \quad | \quad \text{while } E \text{ do } S_1
 \end{array}$$

where E is a boolean expression. Consider the statement

```

if  $c < d$  then  $x = y$ 
     $+ z$ 
else
     $x = y - z$ 
  
```

One possible 3-address code could be

```

if  $c < d$  goto L1 goto
  
```

```
      L2
L1:   x = y + z
      goto L3
L2: x = y - z L3:
      nop
```

We will assume that a three-address statement can be symbolically labeled; the function `newlabel()` returns a new symbolic label each time it is called

Lecture 38

Three-Address Statement Types

Prior to proceeding with flow-of-control construct, here are the types of three-Address statements that we will use

- *Assignment statement*
 $x = y \text{ op } z$
op is a binary arithmetic or logical operation
- *Copy statement*
 $x = y$
value of *y* is assigned to *x*
- *Unconditional jump*
goto L
The three-address statement with label *L* is executed next
- *Conditional jump*
if x relop y goto L
relop is *<*, *=*, *>=*, etc. If *x* stands in relation *relop* to *y*, execute statement with label *L*, next otherwise
- *Indexed assignment*
a) $x = y[i]$
b) $x[i] = y$
In a), set *x* to value in location *i* memory units beyond location *y*.
In b), set contents of location *i* memory units beyond *x* to *y*.

We associate with a boolean expression *E* two labels (attributes); *E.true* and *E.false*. The control flows to *E.true* if the expression evaluates to true, to *E.false* otherwise. Following is syntax-directed translation for

$S \rightarrow \text{if } E \text{ then } S_1$

E.true = newlabel()

E.false = *S.next*

S₁.next = *S.next*

S.code = *E.code* || gen(*E.true* ':') || *S₁.code*

The attribute “**next**” records the label of the next statement to execute. “**code**” is string-valued attribute that holds the actual code generated in the form of a

character string. The code can be eventually written out to a file. The `||` is the string concatenation operator, that is “hello” `||` “ world” will yield the combined string “hello world”.

Suppose E is “a < b”. E.code would be

```
if a < b goto E.true
goto E.false
```

We will discuss semantic rules for boolean expressions shortly

The syntax-directed translation for

$S \rightarrow \text{if } E \text{ then } S_1 \text{ else } S_2$

is

```
E.true = newlabel()
E.false = newlabel()
S1.next = S.next
S2.next = S.next
S.code = E.code || gen(E.true ':') ||
          S1.code ||
          gen('goto' S.next)
          || gen(E.false ':')
          || S2.code
```

Similarly, the syntax-directed translation for the while loop is

$S \rightarrow \text{while } E \text{ do } S_1$

```
S.begin = newlabel()
E.true = newlabel()
E.false = S.next
S1.next = S.begin
S.code = gen(S.begin ':') ||
          E.code ||
          gen(E.true ':')
          || S1.code ||
          gen('goto' S.begin)
```

Lecture 39

Boolean Expressions

In programming languages, boolean expressions have two primary purposes:

- compute logical values such as $x = a < b \ \&\& \ d > e$
- conditional expressions in flow-of-control statements

Consider the grammar for Boolean expressions

$$\begin{array}{l} E \quad \rightarrow \quad E \text{ or } E \\ \quad \quad | \quad E \text{ and } E \\ \quad \quad | \quad \text{not } E \\ \quad \quad | \quad (E) \\ \quad \quad | \quad \text{id relop} \\ \quad \quad | \quad \text{id} \\ \quad \quad | \quad \text{true} \\ \quad \quad | \quad \text{false} \end{array}$$

We will implement the translation for boolean expressions by flow of control method, i.e., representing the value of a boolean expression by a position reached in the program. Here are the syntax directed translation for the grammar rules

$E \rightarrow \text{id}_1 \text{ relop id}_2$
E.code = gen('if id₁ relop id₂ goto E.true) || gen('goto E.false)

$E \rightarrow \text{true}$
E.code = gen('goto E.true)

$E \rightarrow \text{false}$
E.code = gen('goto E.false)

$E \rightarrow E_1 \text{ or } E_2$
E₁.true = E.true
E₁.false = newlabel()
E₂.true = E.true
E₂.false = E.false
E.code = E₁.code || gen(E₁.false ':') || E₂.code

$E \rightarrow E_1 \text{ and } E_2$
E₁.true = newlabel()
E₁.false = E.false
E₂.true = E.true
E₂.false = E.false

$E.code = E_1.code \ || \ gen(E_1.true \ ':') \ || \ E_2.code$
 $\underline{E} \Rightarrow \underline{not \ E_1}$
 $E_1.true = E.false$
 $E_1.false = E.true$
 $E.code = E_1.code$

$\underline{E} \Rightarrow (\underline{E_1})$
 $E_1.true = E.true$
 $E_1.false = E.false$
 $E.code = E_1.code$

Example: Consider the expression

a < b or c < d and e < f

Suppose the true and false exits for the entire expression are **Ltrue** and **Lfalse**.

The syntax directed translation scheme will generate the code

```

    if a < b goto Ltrue goto
    L1
L1:  if c < d goto L2 goto
    Lfalse
L2:  if e < f goto Ltrue goto
    Lfalse

```

Example: Consider the while statement

```

while a < b
  if c < d then x =
    y + z
  else
    x = y - z

```

The translation scheme will generate the following code:

```

L1:  if a < b goto L2 goto
    Lnext
L2:  if c < d goto L3 goto
    L4
L3:  t1 = y + z x =
    t1 goto L1
L4:  t2 = y - z x =
    t2 goto L1
Lnext:  nop

```

Implementation of Syntax-directed Translation

The easiest way to implement syntax-directed definitions is to use two passes: construct a syntax tree for the input in the first pass and then walk the tree in depth-first order evaluating attributes and emitting code. We would like to use only one pass if possible. The problem in generating three-address code in one pass is that we may not know the labels that the control must go to when we generate jump statements. However, by using a technique called *back-patching*, we can generate code in one pass.

As we generate code, we will generate the jumps (conditional or unconditional) with targets temporarily left unspecified. Each such statement will be put on a list of goto statements that have targets missing. We will fill the labels when the proper label can be determined; this is the backpatching step. Backpatching is especially suited for bottom-up parsers.

Assume that the quadruples are put into a simple array. Labels will be indices into this array.

To manipulate list of goto labels, we will use three functions:

1. `makelist(i)`
creates and returns a new list containing only i , the index of quadruple
2. `merge(p1, p2)`
concatenates lists pointed to by p_1 and p_2 and returns the concatenated list.
3. `backpatch(p, i)`
inserts i as the target label for each of the goto statements on list pointed to by p

We now construct a translation scheme suitable for producing quads (IR) for boolean expressions during bottom-up parsing. The grammar we use

is

$$\begin{array}{l} E \rightarrow E_1 \text{ or } M E_2 \\ \quad | E_1 \text{ and } M E_2 \\ \quad | \text{not } E_1 \\ \quad | (E_1) \\ \quad | id_1 \text{ relop } id_2 \\ \quad | \text{true} \\ \quad | \text{false} \end{array}$$
$$M \rightarrow \epsilon$$

We will associate synthesized attributes `truelist` and `falselist` with the nonterminal `E`. Incomplete jumps will be placed on these list.

We associate the semantic action

```
{ M.quad = nextquad() }
```

with the production $M \rightarrow \epsilon$. The function `nextquad()` returns the index of the next quadruple to follow. The attribute **quad** will record this index.

1. $E \rightarrow E_1 \text{ and } M E_2$
{
 `backpatch(E1.trueList,`
 `M.quad); E.trueList =`
 `E2.trueList;`
 `E.falseList = merge(E1.falseList, E2.falseList);`
}

Let's look at the mechanics. If E_1 is false, E is false because of the `and` clause. If E_1 is true, we need to evaluate E_2 . The start of E_1 , i.e., the index of the first quad for E_1 is recorded by `M.quad`; in a bottom up parse, the reduction $M \rightarrow \epsilon$ will occur before reduction to E_2 . The `backpatch` sets the targets of `goto`'s in `E1.trueList` to the start of E_2 .

2. $E \rightarrow E_1 \text{ or } M E_2$
{
 `backpatch(E1.falseList, M.quad);`
 `E.trueList = merge(E1.trueList,`
 `E2.trueList); E.falseList = E2.falseList;`
}

3. $E \rightarrow \text{not } E_1$
{
 `E.trueList =`
 `E1.falseList;`
 `E.falseList =`
 `E1.trueList;`
}

4. $E \rightarrow (E_1)$
{
 `E.trueList = E1.trueList;`
 `E.falseList = E1.falseList;`
}

5. $E \rightarrow id_1 \text{ relop } id_2$
{

```
        E.truelist = makelist(nextquad());
        E.falselist =
        makelist(nextquad()+1);
        emit('if' id1 relop id2 'goto _' )    ;
        emit('goto _ ');
    }
```

6. $E \rightarrow \text{true}$

```
{
    E.truelist = makelist(nextquad());
    emit('goto _ ');
}
```

7. $E \rightarrow \text{false}$

```
{
    E.falselist = makelist(nextquad());
    emit('goto _ ');
}
```

Lecture 40

Example: consider, the boolean expression

$$a < b \text{ or } c < d \text{ and } e < f$$

Recall the syntax directed translation for the production

```
E → id1 relop id2
{
    E.truelist = makelist(nextquad());
    E.falselist = makelist(nextquad()+1);
    emit('if' id1 relop id2 'goto _');
    emit('goto _');
}
```

We carry out a bottom-up parse. In response to reduction of $a < b$ to E , the list $E.truelist$ gets $\{100\}$ and $E.falselist$ gets $\{101\}$ and the two quadruples

100: if a < b goto _

101: goto _

are generated. Notice that the goto's are generated with targets. These are precisely the goto's whose quad indices 100 and 101 are recorded in the truelist and falselist attributes of E . These will be patched later in the parse via the backpatching mechanism.

The next reduction to happen is $M \rightarrow \epsilon$ which is in the production

$$E \rightarrow E_1 \text{ or } M E_2$$

This reduction will eventually take place when reduction to E_2 happens. This marker non-terminal M records the value of `nextquad` which at this time is 102. Next, the reduction of $c < d$ to E leads to the list $E.truelist$ getting $\{102\}$, $E.falselist$ getting $\{103\}$ and the two quadruples

102: if c < d goto _

103: goto _

are generated.

Next reduction is $M \rightarrow \epsilon$. The marker non-terminal M in the production

$$E \rightarrow E_1 \text{ and } M E_2$$

records the value of nextquad which at this time is 104, the quad index of first quad of E_2 . Reducing $e < f$ to E causes E .truelist to get {104}, E .falselist to get {105} and the generation of quads

```
104:  if e < f goto _
105:  goto _
```

We now reduce by the production

$$E \rightarrow E_1 \text{ and } M E_2$$

Recall the semantic actions associated with this rule:

```
E → E1 and M E2
{
    backpatch(E1.truelist, M.quad);
    E.truelist = E2.truelist;
    E.falselist = merge(E1.falselist, E2.falselist);
}
```

The six quadruples generated so far are

```
100:  if a < b goto _
101:  goto _
102:  if c < d goto _
103:  goto _
104:  if e < f goto _
105:  goto _
```

The semantic action calls

```
backpatch({102},104)
```

The backpatch fills in 104 as the target of the goto in quad 102.

```
100:  if a < b goto _
101:  goto _
102:  if c < d goto 104
103:  goto _
104:  if e < f goto _
105:  goto _
```

The next two semantic actions define E .truelist and E .falselist. This way, the synthesized attributes propagate the attributes up the parse tree.

We now reduce by the production

$E \rightarrow E_1 \text{ or } M E_2$

The semantic action calls

`backpatch({101},102)`

which fills in 102 in statement 101:

```
100:  if a < b goto _  
101:  goto 102  
102:  if c < d goto 104  
103:  goto _  
104:  if e < f goto _  
105:  goto _
```

The remaining goto's will have their targets backpatched later in the parse. The attributed parse tree at this stage is

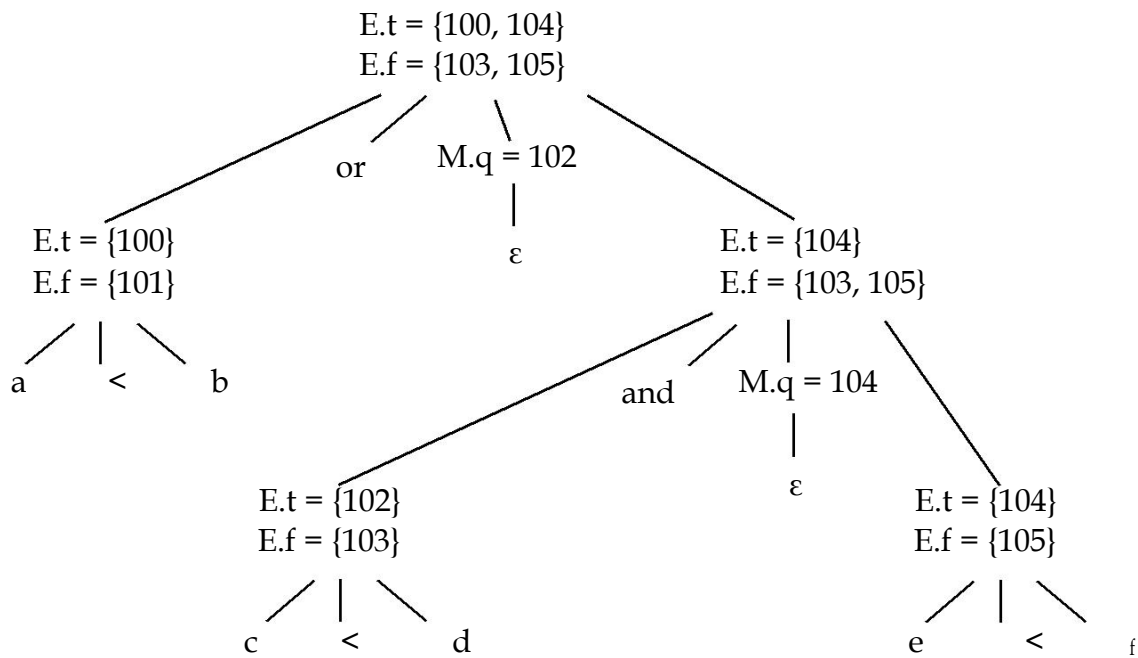

Lecture 41

Flow-of-Control Statements

We now use backpatching to translate flow-of-control statements in one pass. We will use the same list-handling procedures as before.

```
S    →   if E then S
      |   if E then S else S
      |   while E do S
      |   begin L end
      |   A

L    →   L ; S
      |   S
```

The semantic actions associated with each production are

1. $S \rightarrow \text{if } E \text{ then } M_1 S_1 N \text{ else } M_2 S_2$
{
 backpatch(E.truelist, M₁.quad);
 backpatch(E.falselist, M₂.quad);
 S.nextlist = merge(S₁.nextlist, merge(N.nextlist,S₂.nextlist));
}
2. $N \rightarrow \epsilon$
{
 N.nextlist = makelist(nextQuad());
 emit('goto_');
}
3. $M \rightarrow \epsilon$
{
 M.quad = nextQuad();
}
4. $S \rightarrow \text{if } E \text{ then } M S_1$
{
 backpatch(E.truelist, M.quad);
 S.nextlist = merge(E.falselist,S₁.nextlist);
}
5. $S \rightarrow \text{while } M_1 E \text{ do } M_2 S_1$
{

```

        backpatch(S1.nextlist, M1.quad);
        backpatch(E.truelist, M2.quad);
        S.nextlist = E.falselist; emit( 'goto' M1.quad);
    }
6. S → begin L end
    {
        S.nextlist = L.nextlist;
    }

7. S → A
    {
        S.nextlist = nil;
    }

8. S → L1 ; M S
    {
        backpatch(L1.nextlist, M.quad);
        L.nextlist = S.nextlist;
    }

9. L → S
    {
        L.nextlist = S.nextlist;
    }

```

Example: Let go through the example with the following input statement

if $a < b$ or $c < d$ and $e < f$ then $x = y+z$ else $x = y-z$

The bottom-up parse will reduce the compound boolean expression $a < b$ or $c < d$ and $e < f$ to E_1 or $M E_2$ which we have already covered in the previous example. We thus assume that the quads for the boolean expression have been generated. The sentential form at this stage is

if E_1 or $M E_2$ then $x = y+z$ else $x = y-z$

The reduction $E \rightarrow E_1$ or $M E_2$ yields

if E then $x = y+z$ else $x = y-z$

The semantic actions define the synthesized attributes $E.truelist=[100,104]$ and $E.falselist=[103,105]$.

We now trace the remaining bottom up parse and execute the semantic actions:

if E then M ₁ x=y+z else x=y-z	M ₁ → ε { M ₁ .quad = 106 }
⇒ if E then M ₁ A else x=y-z	A → x=y+z { emit('x=y+z') }
⇒ if E then M ₁ S ₁ else A	S ₁ → A { S ₁ .nextlist = nil }
⇒ if E then M ₁ S ₁ N else x=y-z	N → ε { N.nextlist = [107] emit('goto _') }
⇒ if E then M ₁ S ₁ N else M ₂ x=y-z	M ₂ → ε { M ₂ .quad = 108 }
⇒ if E then M ₁ S ₁ N else M ₂ A	A → x=y-z { emit('x=y-z') }
⇒ if E then M ₁ S ₁ N else M ₂ S ₂	S ₂ → A { S ₂ .nextlist = nil }
⇒ S	{ backpatch([100,104],106) backpatch([103,105],108) S.nextlist=[107]}

The array of quadruples at this stage will contain

100	if a < b goto 106
101	goto 102
102	if c < d goto 104
103	goto 108
104	if e < f goto 106
105	goto 108
106	x=y+z
107	goto _
108	x=y-z
109	

Semantic Actions in YACC

The syntax-directed translation statements can be conveniently specified in YACC

The `%union` will require more fields because the attributes vary. The actual mechanics will be covered in the handout for the syntax-directed translation phase of the course project

Lecture 42

Code Generation

The code generation problem is the task of mapping intermediate code to machine code. The generated code must be correct for obvious reasons. It should be efficient both in terms of memory space and execution time.

The input to the code generation module of compiler is intermediate code (optimized or not) and its task is typically to produce either machine code or assembly language code for a target machine.

The code generation module has to tackle a number of issues.

- Memory management: mapping names to data objects in the run-time system.
- Instruction selection: the assembly language instructions to choose to encode intermediate code statements
- Instruction scheduling: instruction chosen must utilize the CPU resources effectively. Hardware stalls must be avoided.
- Register allocation: operands are placed in registers before executing machine operation such as ADD, MULTIPLY etc. Most processors have a limited set of registers available. The code generator has to make efficient use of this limited resource

For our discussion, we will target a machine that has the following general characteristics. Most actual processors are similar to such architecture.

The machine is byte-addressable with 4-byte words. It has N general -purpose registers. It uses two-address instructions of the form *op source, destination*. The target assembly language operations are:

- MOV source, destination
- ADD source, destination
- SUB source, destination (dest = dest - source)
- GOTO address
- CJ conditional jump

More instruction will be added to the instruction set as needed.

The following table presents the addressing modes for source or destination operands.

MODE	FORM	ADDRESS	ADDED COST
absolute	M	M	1
register	R	R	0
indexed	c(R)	c + contents(R)	1
indirect register	*R	contents(R)	0
indirect indexed	*c(R)	contents(c+contents(R))	1
literal	#c	c	1
stack	SP	SP	0
indexed stack	c(SP)	c + contents(SP)	1

We associate a cost with each instruction. This will allow us to compute the cost of generated code. The cost corresponds to length of instruction. For example the instruction

MOV R0,R1 ; R0 = c(R1)

has cost 1 while

MOV R5,M ; M = c(R5)

has cost 2: 1 for instruction, 1 additional for memory address. The column title "ADDED COST" indicates this additional cost.

Simple Code Generation

We start with a simple code generation strategy: define a target code sequence for each intermediate code (such as 3-address code) statement type. Thus,

Intermediate code	becomes...
a = b	MOV b,a
a = b[c]	MOV addr(b),R0 ADD c, R0 MOV *R0,a
a = b + c	MOV b,a ADD c,a
a[b] = c	MOV addr(a),R0 ADD b,R0 MOV c,*R0

Consider the C statement: a[i] = b[c[j]]; the simple code generator will emit

t1 := c[j]	MOV addr(c), R0 ADD j, R0 MOV *R0, t1
t2 := b[t1]	MOV addr(b), R0 ADD t1, R0 MOV *R0, t2
a[i] := t2	MOV address(a), R0 ADD i, R0 MOV t2, *R0

The cost of this code is 18 and we are forced to allocate space for two temporaries. While the simple approach works, it does not produce good code. There a number of reasons for this. The generator considers each IR (3-address in this case) alone and makes local decision. It does not take temporary variables into account. One optimization possible is to get rid of the temporaries:

```
MOV addr(c), R0
ADD j, R0
MOV addr(b), R1
ADD *R0, R1
MOV addr(a), R2
ADD i, R2
MOV *R1, *R2
```

The cost of this code is 12. We can optimize further:

```
MOV addr(c), R0
ADD j, R0
MOV addr(a), R2
ADD i, R2
MOV *addr(b)(R0), *R2
```

The cost of this code is 10. What is needed is a way to generate machine code based on past and future use of the data.

Lecture 43

Control Flow Graph - CFG

A *control flow graph* is the triplet $CFG = \langle V, E, Entry \rangle$, where V = vertices or nodes, representing an instruction or *basic block* (group of statements), $E = (V \times V)$ edges, potential flow of control. Entry is an element of V , the unique program entry.

Basic Blocks

A *basic block* is a sequence of consecutive statements with single entry/single exit. Flow of control only enters at the beginning and only leaves at the end. There can be variants of basic blocks with single entry/multiple exit, multiple entry/single exit.

Generating CFGs

In order to generate a CFG, we partition the intermediate code (3-address code, for example) into basic blocks. Edges are added corresponding to control flow between blocks. An unconditional goto in the IR will lead to a single edge to another or the same block. A conditional goto will lead to multiple edges. If there is no goto at the end of a block, the control passes to first statement of next block.

Here is the algorithm for partitioning intermediate code into basic blocks. The input to the algorithm is a sequence of three-address statements. The algorithm will output a list of basic blocks with each three-address statement in exactly one block.

Algorithm: partition 3-address statements into basic blocks:

1. Determine the set of leaders - the first statements of basic blocks. The rules are:
 - The first statement is a *leader*
 - Any statement that is the target of a conditional or unconditional goto is a leader
 - Any statement that immediately follows a goto or conditional goto is a leader

- For each leader, its basic block consists of the leader and all statements up to but not including the next leader or the end of the program

Example: consider the C fragment for computing dot product $a^T b$ of two vectors a and b of length 20

$$a^T b = a_1 b_1 + a_2 b_2 + \dots + a_{20} b_{20}$$

```
prod = 0; i =
1; do {
    prod = prod + a[i]*b[i]; i = i + 1;
} while ( i <= 20 );
```

The 3-address code for the dot product with the two leaders highlighted

```

1    prod = 0
2    i = 1
3    t1 = 4*i      /* offset */
4    t2 = a[t1]    /* a[i] */
5    t3 = 4*i
6    t4 = b[t3]    /* b[i] */
7    t5 = t2*t4
8    t6 = prod+t5
9    prod = t6
10   t7 = i+1
11   i = t7
12   if i <= 20 goto (3)
```

The two basic blocks are

<pre> 1 prod = 0 2 i = 1</pre>	B ₁ .
<pre> 3 t1 = 4*i /* offset */ 4 t2 = a[t1] /* a[i] */ 5 t3 = 4*i 6 t4 = b[t3] /* b[i] */ 7 t5 = t2*t4 8 t6 = prod+t5 9 prod = t6 10 t7 = i+1 11 i = t7 12 if i <= 20 goto (3)</pre>	B ₂

This yields the following CFG; note that the target of the condition goto at the end of the second block has been replaced by reference to block 2.

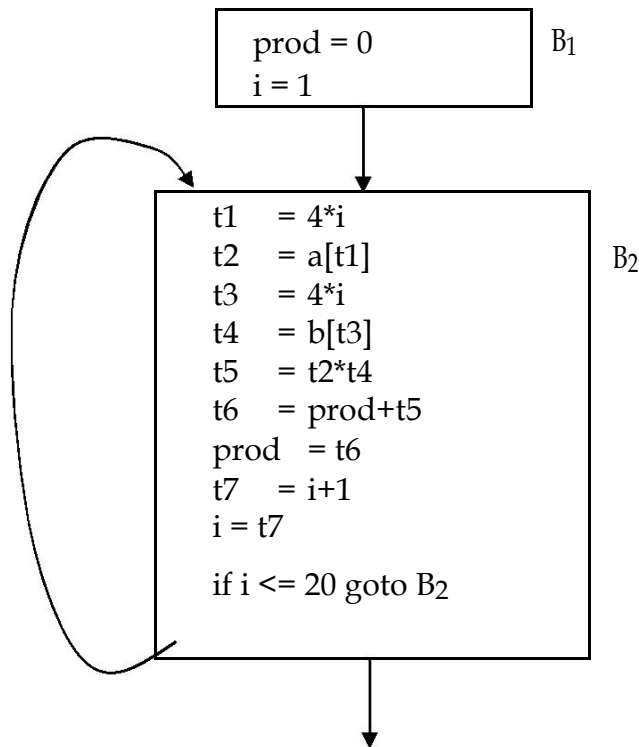

Let us consider a more complex example. Here is the quicksort algorithm encoded as a recursive function in C++

```

i = 1 Quick
Sort
void quicksort(int m, int n)
{
    int i,j,v,x;
    if( n <= m ) return; i=m-1;
    j=n; v=a[n]; while(true) {
        do i=i+1; while( a[i] < v); do j=j-1;
        while( a[j] > v); i( i >= j ) break;
        x=a[i]; a[i]=a[j]; a[j]=x;
    }
    x=a[i]; a[i]=a[n]; a[n]=x; quicksort(m,j);
    quicksort(i+1,n);
}
  
```

The 3-address for the highlighted portion of the routine (the recursive calls have been left out) with the leaders highlighted and the resulting CFG is

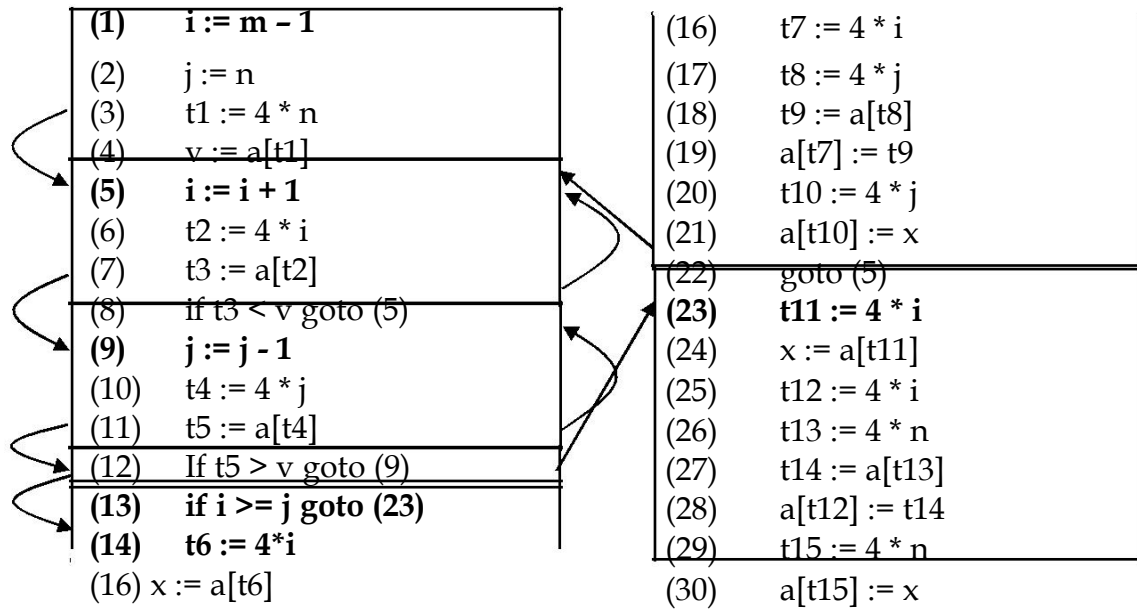

Basic Block Code Generation

The code generation can be carried out at the basic block level. A number of strategies are available to generate code from a basic block. The three we will discuss are

1. Basic - using liveness information
2. Using DAGS - node numbering
3. Register Allocation

In case of the basic code generation strategy, the generator deals with each basic block individually to emit machine code for the block using liveness information. At the end of the block, the generator emits code to save any live values left in registers.

Computing Live/Next Use Information

For the statement:

$$x = y + z$$

x has a *next use* if there is a statement s that references x and there is some way for control to flow from the original statement to s .

$$x = y + z$$

.....

.....

$$s \quad t1 = x - t3$$

A variable is *live* at a given point in time if it has a next use. Liveness tells us whether we care about the value held by a variable. Here is the algorithm for computing live status of variables in a basic block"

Algorithm: Computing live status

Input:

A basic block.

Output:

For each statement, set of live variables

Method:

1. Initially all non-temporary variables go into live set.
2. for $i =$ last statement to first statement:
for statement $i: x = y \text{ op } z$
attach to statement i , current live set. remove x from set.
add y and z to set.

Lecture 44

Example: let us apply the algorithm to the following segment of 3-address code:

```
a = b + c
t1 = a * a
b = t1 + a
c = t1 * b
t2 = c + b
a = t2 +
t2
```

```
live = {b,c}
a = b + c
live = {a}
t1 = a * a
live = {a,t1}
b = t1 + a
live = { b,t1}
c = t1 * b
live = {b,c}
t2 = c + b
live = {b,c,t2}
a = t2 + t2
live = {a,b,c}
```



Basic Code Generation

With live/next use information computed, the basic code generation algorithm proceeds as follows. Process the 3 -address instructions from beginning to end of a block. For each instruction, use machine registers to hold operands whenever possible. A non-live value in a register can be discarded, freeing that register. The code generator uses two data structures for keeping track of register usage:

1. Register descriptor - register status (empty, inuse) and contents (one or more "values")
2. Address descriptor - the location (or locations) where the current value for a variable can be found (register, stack, memory)

Instruction type: $x = y \text{ op } z$

1. If y is non-live and in register R (alone) then generate

OP z' , R

where z' = best location for z . i.e., lookup address descriptor for z . Prefer register location if z is present in a register.

2. If operation is commutative, z is non-live and is in register R (alone), generate

OP y' , R

(y' = best location for y)

3. If there is a free register R, generate

MOV y' , R
OP z' , R

4. Use a memory location. Generate

MOV y' , x
OP z' , x

After generating machine instructions, update information about the current best location of x . If x is in a register, update that register's information (descriptor). If y and/or z are not live after this instruction, update register and address descriptors according.

Let us return to the 3-address code example and apply the basic code generation algorithm. Recall the basic block with liveness information:

```
live = {b,c}
a = b + c
live = {a}
t1 = a * a
live = {a,t1}
b = t1 + a
live = { b,t1}
c = t1 * b
live = {b,c}
t2 = c + b
live = {b,c,t2}
a = t2 + t2
live = {a,b,c}
```

Initially

three registers:
(-, -, -) all
empty current

values:

(a,b,c,t1,t2) = (m,m,m, -, -)

1: a = b + c,

Live =

a

getreg(): L = R1

MOV b,R1

ADD c,R1 ; R1 := R1 + c

Registers: (a, -, -)

current values: (R1,m,m, -, -)

2: t1 = a * a, Live

= a,t1

L = R2 (since a is
live) MOV

R1,R2

MUL R2,R2 ; R2 = R2* R2

Registers: (a,t1, -)

current values: (R1,m,m,R2, -)

3: b = t1 + a,

Live = b,t1

Since a is not live L = R1

ADD R2,R1 ; R1 = R1+R2

Registers: (b,t1, -)

current values: (m,R1,m,R2, -)

4: c = t1 * b, Live

= b,c

Since t1 is not live L = R2

MUL R1,R2 ; R2 = R1*R2

Registers: (b,c, -)

current values: (m,R1,R2, -, -)

5: t2 = c + b,

Live =

b,c,t2 L =

R3

MOV R2,R3

ADD R1,R3 ; R3 = R1+R2

Registers: (b,c,t2)

current values: (m,R1,R2, -,R3)

6: a = t2 + t2,

Live =
a,b,c
ADD R3,R3
Registers: (b,c,a)
current values: (R3,R1,R2,-,R3)

End of block

move all live variables to
memory: MOV R3,a
MOV R1,b
MOV R2,c
all registers
available

Thus the machine code (assembly language) generated is

```

; a := b + c
    LOAD b,R1
    ADD c,R1          ; R1 := R1 + c
; t1 := a * a
    MOV R1,R2
    MUL R2,R2        ; R2 = R2* R2
; b := t1 + a
    ADD R2,R1        ; R1 = R1+R2
; c := t1 * b
    MUL R1,R2        ; R2 = R1*R2
; t2 := c + b
    MOV R2,R3
    ADD R1,R3        ; R3 = R1+R2
; a := t2 + t2
    ADD R3,R3
    MOV R3,a         ; mov live
                    ; var to
                    ; memory
    MOV R1,b
    MOV R2,c

```

Lecture 45

Liveness information allows us to keep values in registers if they will be used later. An obvious concern is why do we assume all variables are live at the end of blocks? Why do we need to save live variables at the end? It seems reasonable to perceive that we might have to reload them in the next block. To do this, we need to determine live/next use information across blocks and not just within a block. This requires global data-flow analysis.

Global Data-Flow Analysis

A Directed Acyclic Graph (DAG) for a basic block has the following labels for the nodes:

- Leaves are labeled by unique identifiers.
- Interior nodes are labeled by operator symbols.
- Nodes can have multiple labels since they represent computed values.

Algorithm: Generate DAG from 3-address code

For statement $i: x = y \text{ op } z$

- if $y \text{ op } z$ node exists,
 add x to the label for that node.
 else
 add node for $y \text{ op } z$.
- if y or z exist in the dag,
 point to existing locations
 else
 add leaves for y and/or z and
 have the op node point to
 them.
- label the op node with x .
- if x existed previously as a leaf,
 subscript that previous
 entry.
- if x is associated with other interior nodes,
 remove them from that list.

Here and an example of the DAG generated for the 3-address code

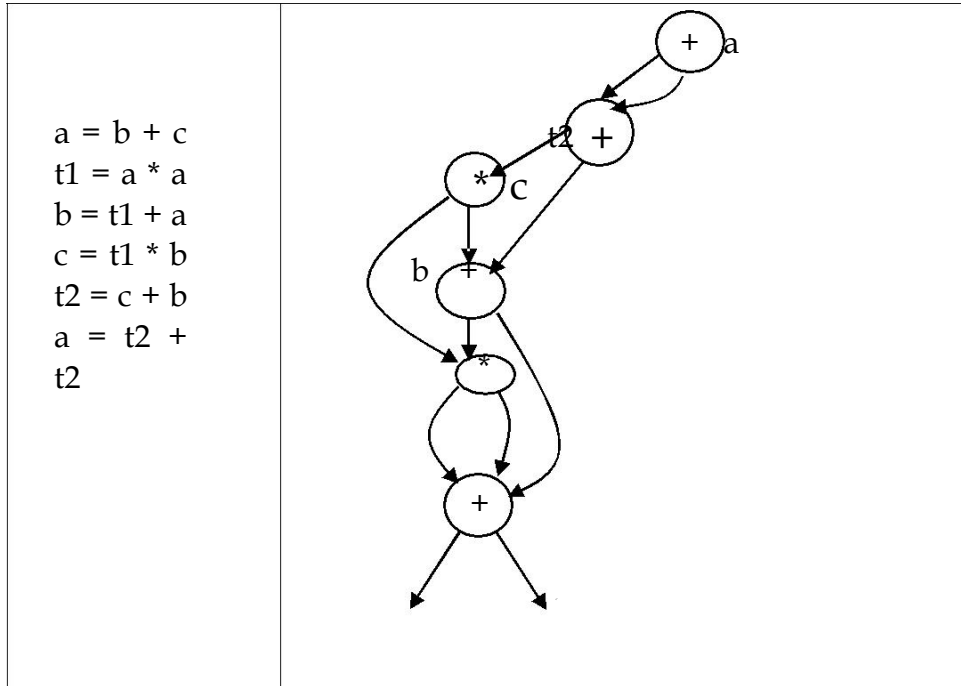

Here is another example

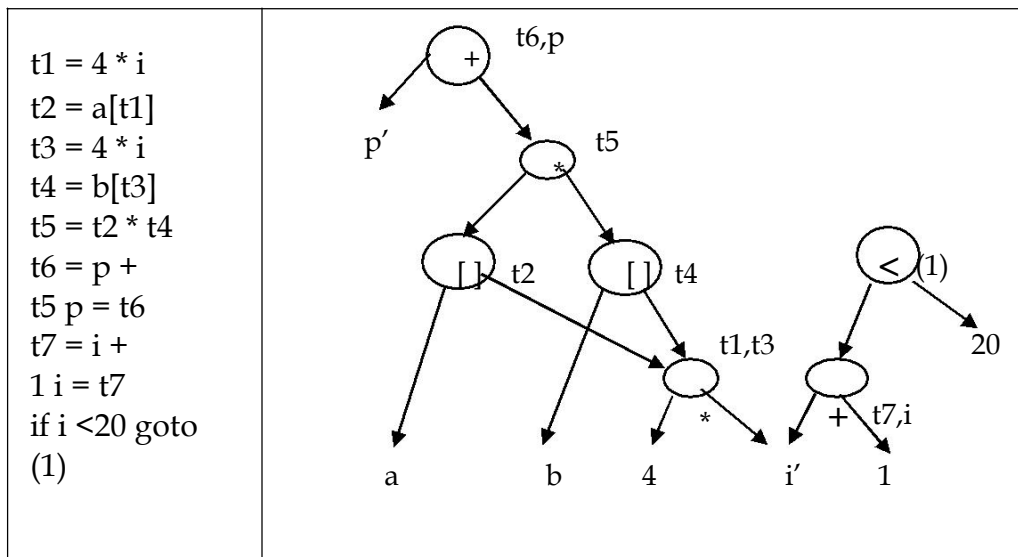

DAGs and optimization

DAGs play an important role in code optimization. It is possible to detect *common sub-expressions* and eliminate them; a node in the DAG with more than one parent is common sub-expression.

The order in which the DAG is traversed can lead to better code. For example, the following DAG can be traversed in two ways:

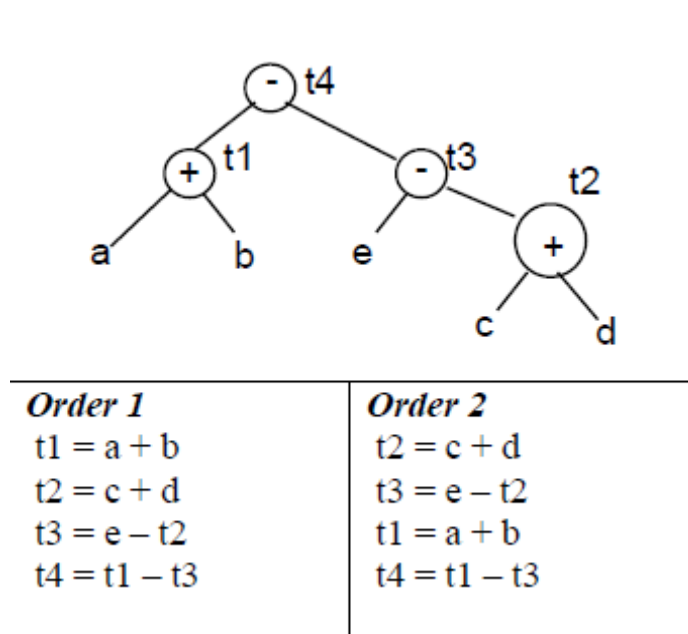

The code generated for order one with 2 registers is

```
MOV a, R0
ADD b,R0
MOV c, R1
ADD D, R1
MOV R0,t1
MOV e, R0
SUB R1,R0
MOV t1,R1
SUB R0, R1
MOV R1,t4
```

Ten machine instructions are generated.

Whereas, order #2 with 2 registers leads to

```
MOV c, R0
ADD D, R0
```

```
MOV e, R1
SUB R0,R1
MOV a,R0
ADD b, R0
MOV R0,t4
```

Only seven instructions are required, a saving of three machine instructions. Reordering improved code because computation of t4 immediately followed computation of t1, its left operand. t1 must be in a register and it is.

Register Allocation

Registers in a machine are a scarce resource. The issue faced by the code generator is this how to best use the bounded number of registers. The matter is complicated by the fact that a few registers are reserved for special purposes. For example, the program counter is kept in a registers. A register is used for the keeping track of the top of the function call stack. Certain operators require multiple registers, often in pairs. Division is an example of such an operator.

The general register allocation problem is NP- complete. Heuristic algorithms exist to solve the problem. One such strategy is the by using the *graph coloring* algorithm: given a graph, color the nodes with different colors such that no two nodes that have an edge between them have the same color. Here is how the graph coloring algorithm can be used to compute register allocation for K registers in a machine.

Algorithm: K registers allocation with graph coloring

1. Compute liveness information.
2. Create interference graph G
3. one node for each variable, an edge connects two variables if one is live at a point where the other is defined
4. Simplify: for any node m with less than K neighbors, remove it from the graph and push it onto a stack. If $(G - m)$ can be colored with K colors, so can G. If we reduce the entire graph, goto step 5.
5. Spill: if we get to the point where we are left with only nodes with degree $\geq K$, mark some node for potential spilling (to memory). Remove and push onto stack. Back to step 3.
6. Assign colors: starting with empty graph, rebuild graph by popping elements off the stack and assigning a color different from neighbors.

Potential spill nodes may or may not be colorable.

Process may require iterations and rewriting of some of the code to create more temporaries.

Let us apply the algorithm to the following 3-address code

		<i>live</i>
a	= b + c	{a}
t1	= a * a	{t1,a}
b	= t1 + a	{b,t1}
c	= t1 * b	{b,c}
t2	= c + b	{b,c,t2}
a	= t2 + t2	{a,b,c}

The interference graph generated is

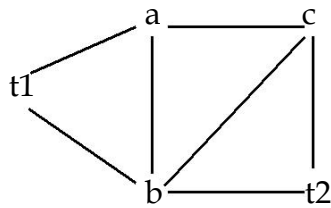

Upon coloring the nodes, the final register allocation assuming 3 registers is

